

Operating instruction

Cito 500 2in1

SAM EU

Article Number: i00020896





The power to move

Table of contents

1	About this manual	6
1.1	Further requirements	6
1.2	Conventions of presentation	7
1.3	Abbreviations	8
1.4	Locations and contact information	9
2	Safety	10
2.1	Warnings	10
2.1.1	Sectional warnings	11
2.2	Intended use	11
2.3	Foreseeable misuse	11
2.4	Safety instructions for the user	11
2.5	Personnel qualification	11
2.6	Dangers and residual risks	12
2.7	Electrical voltage	12
2.8	Incorrect handling	12
3	Transport, packaging and storage	14
3.1	Transport Inspection	14
3.2	Storage conditions	14
3.3	Transport with lifting gear	15
4	Product description	17
4.1	Design	17
4.2	Series label	18
4.3	Technical specifications	19
4.3.1	General information	19
4.3.2	Connections	19
4.3.3	Electrical characteristics	19
4.3.4	Protective devices	20
4.3.5	Ambient conditions	20
4.3.6	Mechanical data	20
4.3.7	Communication interfaces	21
4.3.8	Legal regulations	21
5	Installation	23
5.1	Location	23
5.2	Mechanical installation	24
5.2.1	Installation on asphalt or concrete surfaces	25
5.2.2	Installation with concrete base	28
5.2.3	Base plate	30
5.2.4	Housing closure	30

5.2.5	Changing the locking cylinder	31
5.3	Electrical installation.....	32
5.3.1	Power supply cable	34
5.3.2	Equipotential bonding.....	35
5.3.3	Data connection via RJ45 plug.....	36
6	Start-up	38
6.1	Testing the charging system	38
6.2	System start-up	39
7	Operation.....	40
7.1	Charging process.....	41
7.2	Charging the vehicle	42
7.2.1	"Charge for free".....	42
7.2.2	Authorisation	42
7.2.3	Charging with type 2 socket.....	43
7.2.4	Charging with CCS plug	43
7.3	Ending the charging process	43
7.3.1	End "Charge for free".....	43
7.3.2	Authorisation	44
7.3.3	Ending charging with type 2 socket.....	45
7.3.4	Ending charging with CCS plug.....	45
7.3.5	Retrieve billing data.....	45
7.4	Operating Signals and Displays.....	47
7.4.1	Status LED displays.....	47
7.4.2	Displays.....	48
7.4.3	Acoustic signals.....	48
8	Malfunctions	49
8.1	Residual current circuit breaker (RCCB).....	49
8.2	Circuit breaker (MCB)	49
9	Troubleshooting information.....	50
9.1	About this information.....	50
9.2	Scope of application	50
9.3	OCPP 1.6	50
9.4	Compleo-specific.....	51
10	Maintenance	54
10.1	Maintenance plan	55
10.2	Maintenance work	55
10.2.1	Replacing the filter mat at the air outlet	55
10.2.2	Replacing the filter mat at the air inlet.....	56
10.3	Maintenance and repair	56
10.4	Cleaning.....	56

11 Decommissioning, dismantling and disposal	58
11.1 Disposal	58
12 Annexes.....	60
12.1 Unit dimensions	60
12.2 Commissioning and test reports.....	61
12.2.1 DC-Prüfprotokoll_V1.9	62
12.3 Memory and display module SAM	67
12.3.1 SAM_EU_rev05.pdf	68

1 About this manual

This manual contains descriptions and important information for the safe and trouble-free use of the charging system.

The manual is part of the charging system and must be accessible at all times to all persons working on and with the charging system. The manual must be kept in a clearly legible condition.

The personnel must have carefully read and understood this manual before starting any work. The basic prerequisite for safe working is the observance of all specified safety and warning instructions as well as handling instructions in this manual.

In addition to the instructions in this manual, the local accident prevention regulations and the national industrial safety regulations apply.

Illustrations are for basic understanding and may differ from the actual design of the charging system.

Additional information on the product: <https://www.compleo-charging.com/produkte/document-center>.

1.1 Further requirements

The operator must ensure that the product is properly installed and used as intended.

During installation and start-up, the national legal requirements and regulations for accident prevention must be observed. In Germany these include the requirements according to DIN VDE 0100 and the accident prevention regulations according to DGUV V3.

Before the product is released, an appropriate test must be carried out to ensure all safety features and the proper functionality of the product. In addition, the operator must ensure the operational safety of the product by means of regular maintenance (see chapter *10 Maintenance, page 54*).

This document reflects the state-of-the-art of the product at the time of publication.



NOTICE

Compliance with regulations

The normative references and regulations according to which the product was designed and constructed are listed in the declaration of conformity. When installing and commissioning a product from Compleo Charging Solutions, nationally applicable standards and regulations must also be observed.



INFORMATION

Validity of standards and regulations

All standards, regulations, test intervals and the like mentioned in this document are valid in Germany. If a system is set up in another country, equivalent documents with a national reference must be used.

1.2 Conventions of presentation

For easy and quick understanding, different information in this manual is presented or highlighted as follows:

- List without fixed order
- List (next item)
 - Subitem
 - Subitem
- 1. Handling instruction (step) 1
- 2. Handling instruction (step) 2
 - ⇒ Additional notes for the previous step

(1) Position number in figures and keys

(2) Consecutive position number

(3)...

Reference (example): See "chapter 6.5, page 27"



INFORMATION

Information contains application tips, but no hazard warnings.

1.3 Abbreviations

Abbreviation	Explanation
AC	Alternating Current
BM	Floor mounting on prefabricated base or load-bearing ground
CCS	Combined Charging System
CHA	Abbreviation for plug designation: CHAdeMO
DC	Direct Current
eHZ	electronic domestic meter
EMC	Electromagnetic Compatibility
fleet	Charging station with busbar system
HAK	Domestic junction box
IMD	Insulation Monitoring Device IEC 61557-8
IMS	Intelligent measuring system
CMS	Cable management system
MCB	Miniature Circuit Breaker
MessEG	Measuring and calibration law
MessEV	Measuring and calibration regulations
N/A	Not Available/ Applicable
OCPP	Open Charge Point Protocol
PT	Payment Terminal
RCD	Residual Current Device
RDC-DD	Residual Direct Current-Detecting Device
S/N	Serial number
SAM	Memory and display module
SPD	Surge Protective Device
SVHC	Substance of Very High Concern
UV	Sub-distribution
WLL	Work Load Limit

1.4 Locations and contact information

 Compleo Charging Solutions GmbH & Co. KG Ezzestraße 8 44379 Dortmund, Germany	+49 231 53492370 info@compleo-cs.com compleo-charging.com
 Compleo Charging Solutions UK Ltd. The Lambourn, Wyndyke Furlong Abingdon, OX14 1UJ, United Kingdom	+44 1235 355189 hello.uk@compleo-cs.com compleocharging.co.uk
 Compleo Charging Solutions AG Switzerland Hardturmstrasse 161 8005 Zurich, Switzerland	info.ch@compleo-cs.com compleo-charging.ch
 Compleo Charging Solutions GmbH Campus 21, Liebermannstraße F05, 402/7 2345 Brunn am Gebirge, Austria	info@compleo-cs.com compleo.at
 Compleo CS Nordic AB Derbyvägen 4 212 35 Malmö, Sweden	+46 40 6850500 info.sweden@compleo-cs.com compleocs.se

2 Safety

To ensure operational safety of the charging equipment and to avoid serious injuries caused by flashovers or short circuits, the following information and safety instructions for operating the unit must be observed.

Repair work on the unit must only be carried out by authorised specialist personnel. The housing of the unit may only be opened by persons who have been properly instructed.

The following points always apply:

- Read and observe safety and warning instructions
- Read and follow instructions

2.1 Warnings

In this manual, warnings and notes are presented as follows.



DANGER

Indicates an imminent danger that will result in death or serious injury if not avoided. There is great danger to life.



WARNING

Indicates a potentially hazardous situation which could result in death or serious injury if not avoided.



CAUTION

Indicates a potentially hazardous situation which may result in minor or moderate injury if not avoided.



NOTICE

Indicates a potentially hazardous situation which may result in property damage if not avoided.

2.1.1 Sectional warnings

Sectional warnings refer to entire chapters, a section or several paragraphs within this manual.

Sectional warnings are presented as follows (example warning):



WARNING

Type and source of the danger

Possible consequences if the danger is ignored.

- Measures to avoid the danger.

2.2 Intended use

The charging system is intended exclusively for charging electric vehicles.

The charging system is suitable for public and semi-public areas and can be used indoors and outdoors.

The charging system is intended exclusively for stationary installation.

Any use beyond this is considered improper use. The manufacturer is not liable for damages resulting from this.

2.3 Foreseeable misuse

The use of the charging system as a power source for other power consumers is not in accordance with its intended use and is considered misuse.

Only type 2/ 20 A or type 2/ 32 A charging cables that comply with the product standard IEC 62196-2:2016; EN 62196-2:2017 may be used on charging systems equipped with a type 2 charging socket. Charging cables that deviate from the above are not accepted by the systems.

Charging systems may only be connected to the power supply via a fixed and non-separable supply line.

2.4 Safety instructions for the user

This charging system may only be used in the manner described in this manual. If the charging system is used for other purposes, the operator may be endangered and the charging equipment may be damaged. This manual must always be accessible. Note the following points:

- If no charging process is active, anchor any existing charging cables on the charging system in the brackets provided or wrap them around the housing of the charging system.
- The distance between a charging system and a vehicle must not exceed 3 metres.
- The charging system may only be operated when completely closed. Do not remove covers inside the charging system.

2.5 Personnel qualification

Qualified and trained electricians meet the following requirements:

- Knowledge of general and special safety and accident prevention regulations.
- Knowledge of the relevant electrotechnical regulations.
- Product-specific knowledge through appropriate training.
- Ability to identify hazards associated with electricity.



DANGER

Danger due to electric current

Touching live parts will result in electric shock with serious injury or death.

- Work on electrical components may only be carried out by a qualified electrician and in accordance with electrotechnical regulations.
- Ensure absence of voltage and take suitable protective measures.

2.6 Dangers and residual risks



NOTICE

Compleo charging systems as a whole do not contain SVHCs (Substances of Very High Concern) in a concentration of more than 0.1 % (w/w), related to the individual charging station. However, individual components may contain SVHCs in concentrations > 0.1 % (w/w).

- When the charging stations are used as intended, no SVHCs are released and there are no risks to humans or the environment.

2.7 Electrical voltage

Dangerous electrical voltages may be present inside the housing of the charging system after the housing has been opened. There is a danger to life if contact is made with live components. Serious injury or death is the result.

- Work on electrical equipment may only be carried out by a qualified electrician and in accordance with electrical engineering rules.
- Disconnect the charging system from the power supply.

2.8 Incorrect handling

- Pulling on the charging cable can lead to cable breakage and damage. Only pull the charging cable out of the socket directly at the plug.
- The use of extension cables is not permitted. To avoid the risk of electric shock or cable fire, only one charging cable may be used at a time to connect the electric vehicle and charging system.
- A charging system whose charging cables are in contact with the ground involves a risk of tripping or mechanical damage if run over. The operator of the charging system must implement appropriate measures for cable routing and affix appropriate warnings.

**⚠ WARNING****Risk of electric shock and fire due to the use of adapters**

Using adapters on the charging cable can cause serious injury and damage to property.

- Do not use any adapters on the charging cable.

3 Transport, packaging and storage

3.1 Transport Inspection

Depending on the type and scope of the product, it is delivered either upright or horizontally in appropriate transport and protective packaging.

Air-cushioned protective films and/or cardboard packaging are used. These materials can also be used as underlay during subsequent assembly.

1. After unpacking, thoroughly inspect the product for transport damage.
2. Compare the serial number of the product with that of the delivery documents to exclude faulty deliveries.
3. Check delivery according to purchase and scope of delivery for completeness.
4. Proceed as follows in case of deviations or recognisable damages:
 - Do not accept delivery or only accept it conditionally.
 - Complaints must be reported immediately to the manufacturer in writing.



NOTICE

We recommend keeping and reusing the original packaging for further transportation. Otherwise, the packaging material must be disposed of in accordance with the applicable local regulations.



INFORMATION

Do not tilt or place the loading system on its side.

3.2 Storage conditions

The system should be stored in the same position that it was transported in. If this is not possible for undetermined reasons, it should be stored in the installation position of the product.

- Ambient temperature for storage: -25 °C to +50 °C
- Permissible relative humidity: maximum 95 % (non-condensing)
- For intermediate storage, store the product in its original packaging

3.3 Transport with lifting gear

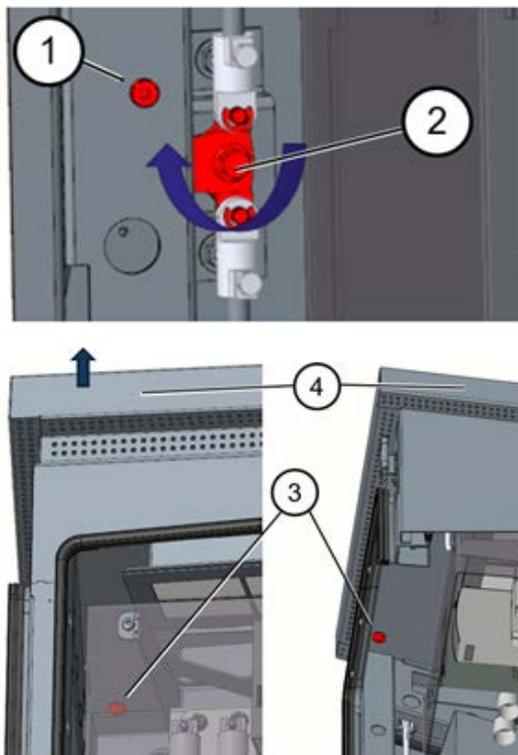


WARNING

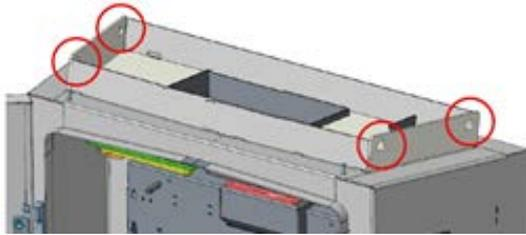
Suspended loads

Falling loads can cause serious injury or death.

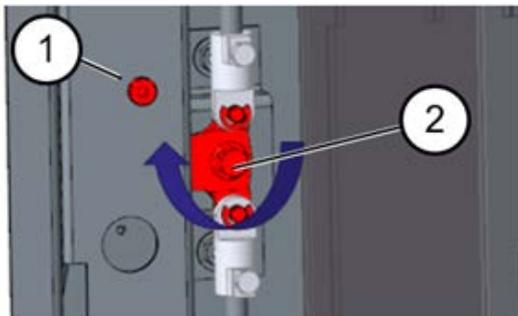
- Never step under suspended loads.
- Attach slings only to the designated attachment points.
- Only use approved lifting gear and slings in perfect condition with sufficient load capacity.
- Transport the load close to the ground and set it down immediately after transport to its destination.



1. Open the door of the charging station.
2. Unscrew the screw approx. 10 mm (1).
3. Turn the locking lever of the left door 90 ° upwards (2) and open the left side door.
 - ⇒ Make sure that no cables are damaged.
 - ⇒ The cover need not be removed.
4. Repeat the above steps for the right-hand door.
5. Unscrew four screws (3) under the roof.
6. Remove the roof (4) upwards.
7. Place the roof on a soft surface to avoid scratches.



11. Transport the charging station to its destination and set it down safely.
12. Put the roof back on and screw it on.
13. Insert the cover.
14. Screw the cover back on.



8. Bring suitable lifting gear into position.
 - ⇒ WLL lifting gear > 250 kg.
9. Attach suitable ropes with shackles to the four attachment points.
10. Lift the charging station slowly and ensure that it hangs vertically.
15. Close left side door of the charging station, lock it (2) and screw the screw back in (1).
16. Repeat the above steps for the right-hand door.
17. Lock the doors of the charging column.

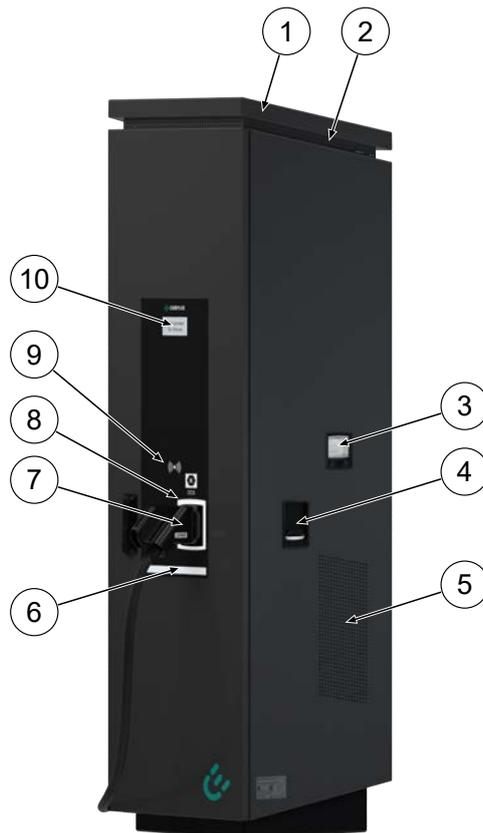
4 Product description

The charging system described below Cito 500 2in1 – EU, mounted on solid ground or base, is designed for charging electric vehicles indoors and outdoors.

Instructions, states and messages are indicated by means of status LEDs and/or displays.

The charging system has two charging points where parallel charging is possible.

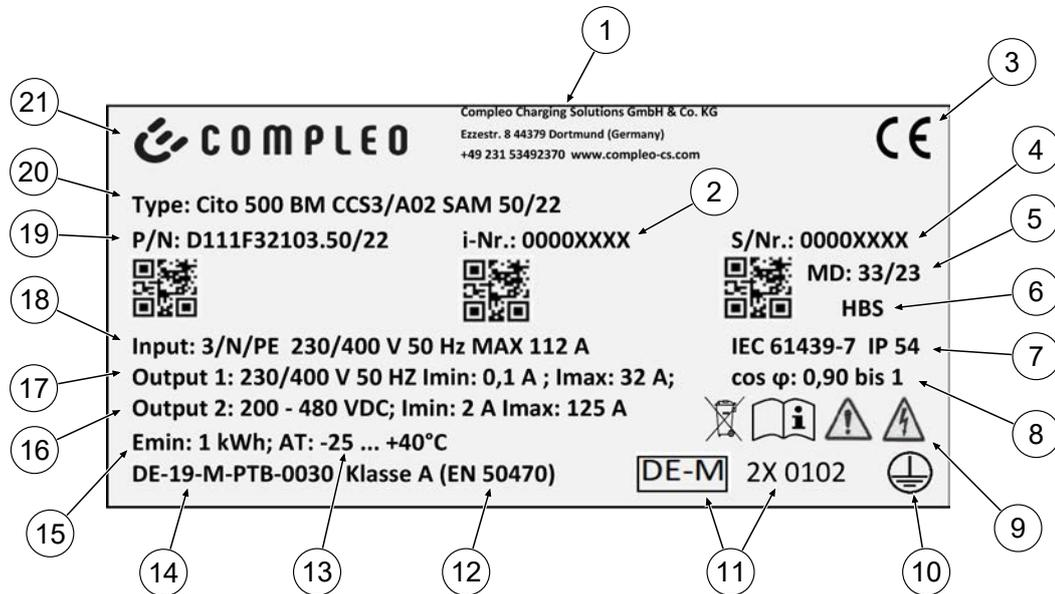
4.1 Design



- (1) Cover (roof)
- (2) Air outlet
- (3) SAM AC display and storage module;
alternatively: Meter display
- (4) Charger interface, socket type 2
- (5) Air Inlet
- (6) Near field lighting
- (7) Charger interface CCS
- (8) Status display of the charger
interfaces
- (9) RFID field
- (10) Information display

4.2 Series label

There is a serial label on the charging system. The following figure shows an example of the arrangement of information on a serial label:



The serial label can be used to identify the following information:

- (1) Company name
- (2) Article number
- (3) CE marking
- (4) Serial number
- (5) Calendar week and year of manufacture
- (6) Place of manufacture
- (7) Manufacturing standard, protection type and protection class
- (8) Active power rating
- (9) Pictograms (safety, operating manual, disposal)
- (10) Protection class
- (11) Metrology marking
- (12) Accuracy class of the measuring instrument according to EN 50470
- (13) Ambient temperature
- (14) Number of the type examination certificate
- (15) Minimum energy import (compliant with calibration law)
- (16) Output 2: Voltage range, frequency, min. current, max. current
- (17) Output 1: Voltage range, frequency, min. current, max. current
- (18) Input: Number of phases, voltage, frequency, max. input current
- (19) Material number
- (20) Type/ Installation type/ Charging interfaces/ Charging capacity
- (21) Manufacturer

4.3 Technical specifications

4.3.1 General information

Charging system	Cito 500 2in1 - EU
Article number	i00020896
Charging standard	Mode 3 and Mode 4 / IEC 61851
DC charger interface	1 x CCS plug with attached cable
AC charger interface	1x type 2 socket (sliding or folding)

4.3.2 Connections

Mains connection	Terminals
Max. connection cross-section ¹⁾	70 mm ² with M8 compression cable lug
Max. equipotential bonding ⁶⁾¹⁾	Round wire V4A: Ø 10 mm ² ; H07V-K: 35 mm ² with M8 compression cable lug
Ethernet	Cable connection
Min. connection cross-section	26 AWG
Max. length	30 m

4.3.3 Electrical characteristics

Mains voltage	400 V/ 3~
Max. rated current	112 A/ 3~
Network form	TT/ TN
Protection class	I
Overvoltage category	III
Mains frequency	50 Hz
Max. DC charging capacity per charging point	50 kW

Max. AC charging capacity per charging point	22 kW
DC charging voltage	200 – 480 V
AC charging voltage	400 V/ 3~
DC charging current	125 A
AC charging current	32 A
Rated short-time withstand current (I _{cw})	(400 V AC) 6 kA
Max. pre-fuse	125 A gG/gL

4.3.4 Protective devices

RCD ⁴⁾	RCCB: 40 A/0,03 A, type A; RDC-DD: 6 mA
MCB ²⁾	1 x C100A, 1 x B16A
SPD ⁵⁾	ÜS 1/2/3 – DIN EN 61643-11

4.3.5 Ambient conditions

Ambient temperature	-25 °C to +40 °C
Operating temperature (Ø 24 h)	≤ 35 °C
Storage temperature	-25 °C to +50 °C
Relative humidity	≤ 95 % (non-condensing)
Altitude	≤ 2000 m above sea level

4.3.6 Mechanical data

Dimensions (H x W x D)	1995 x 640 x 511
Max. weight	250 kg
Housing	Stainless steel (powder-coated)
Housing closure	Pivoted lever mechanism for locking cylinder
Impact resistance level	IK10

Protection type	IP54
Degree of contamination	3
Type/mounting	Ground or base mounting

4.3.7 Communication interfaces

Data communication	TCP/IP
Data connection (frequency/ transmission power)	LTE modem (800 MHz, 900 MHz, 1800 MHz, 2100 MHz, 2600 MHz/ 23.0 ±1 dBm)
Back-end communication	OCPP 1.5, OCPP 1.6
RFID standard (frequency/ transmission power)	ISO/ IEC 14443 (13.56 MHz/ 13.9 mW, 11.4 dBm) (125 kHz; 134.2 kHz/ 26 mW, 14.1 dBm)

4.3.8 Legal regulations

2014/53/EU (Radio Equipment Directive)		
2011/65/EU (RoHS Directive)		
2001/95/EG (Directive on General Product Safety)		
2012/19/EU (WEEE Directive)		
(EU) 2019/1021 (EU-POP Ordinance)		
(EU) 1907/2006 (REACH Regulation)		
SVHC	EU no.	CAS no.
Lead (Pb)	231-100-4	7439-92-1
4,4' isopropylidendiphenol (bisphenol A; BPA)	201-245-8	80-05-7
Lead(II) oxide (PbO)	215-267-0	1317-36-8
N,N-dimethylacetamide	204-826-4	127-19-5
Diboron trioxide	215-125-8	1303-86-2
N,N-dimethylformamide	200-679-5	68-12-2

Dodecamethylcyclohexasiloxan (D6)	208-762-8	540-97-6
Decamethylcyclopentasiloxan (D5)	208-764-9	541-02-6
Octamethylcyclotetrasiloxan (D4)	209-136-7	556-67-2
Lead titanium zirconium oxide	235-727-4	12626-81-2
Lead titanium trioxide	235-038-9	12060-00-3

- 1) = *Use copper conductors only.*
- 2) = *Circuit breaker must be located in the sub-distribution upstream of the charging system if the charging system is not equipped with it.*
- 3) = *according to IEC 60898-1, IEC 60947-2 or IEC 61009-1 (deviations possible due to country-specific regulations).*
- 4) = *Residual current circuit breakers must be installed upstream of the charging system if the charging system is not equipped with it.*
- 5) = *Overvoltage protection must be installed upstream of the charging system if the charging system is not equipped with it.*
- 6) = *Only when equipped with surge protection device type 1/2/3 - DIN EN 61643-11.*

5 Installation

The assembly and installation work requires specific technical qualifications and expertise. There is a danger to life for persons who carry out work for which they have neither been qualified nor instructed. The work may only be carried out by persons who are familiar with it, have been informed about dangers and have the necessary qualifications.

Observe the national legal requirements and regulations during assembly and installation.

5.1 Location

For professional installation, safe operation and barrier-free access to the charging system, the following points must be observed when selecting the location.

- Do not install the charging system in the hazard areas of:
 - flammable, combustible and explosive materials
 - running or jet water
- Do not install the charging system in the following areas:
 - Areas that are potentially explosive (e.g. petrol stations)
 - Areas where backwater or storm water can be expected
 - Areas where flooding can be expected
 - Areas where heat domes or heat accumulation can occur
- The substrate must have sufficient strength and load-bearing capacity to withstand the mechanical loads.
- Provide sufficient space to maintain the minimum distances:
 - Approx. 120 cm between two charging systems
 - 3 cm from the rear of the charging system to other objects
- Ensure heat dissipation and a sufficient fresh air supply for cooling the charging system.
- Observe ambient conditions, see also chapter 4.3 *Technical specifications, page 19*.
- Ensure a stable LTE connection. If necessary, switch to LAN or external LTE antenna. It is recommended to install a duplex network cable (CAT 7).



INFORMATION

This charging system is not suitable for use in residential areas and may not provide adequate radio reception protection in these areas.

5.2 Mechanical installation



WARNING

Incorrect installation and start-up

Improper performance of work can lead to serious injuries and damage to property.

- Only allow work to be carried out by trained specialist personnel.
- Before installation, fulfil all safety-related conditions.
- Carry out mechanical installation only when the system is in a de-energised state.

- Provide sufficient free space for the installation.

The installation site must be sufficiently accessible so that the charging system can be installed and serviced without interference.

- Choose the installation site so that the cables of the optional cable management system do not protrude onto the road and do not come to rest between the kerb and the road.
- Use a suitable lifting tool with sufficient load capacity during installation.



INFORMATION

To protect the charging system, we recommend to install an approach limiter (e.g. bollard).

5.2.1 Installation on asphalt or concrete surfaces

Installation sequence

1. Select a suitable installation site.
2. Check ground for stability.
3. Check parts and installation material for completeness.
4. Lay the supply lines¹⁾.
5. Measure and drill fixing holes on the ground.
6. Insert ground anchorage.
7. Place and align the charging system.
8. Fasten the charging system with installation material.
9. Prepare electrical installation.



The adjacent illustration opposite shows a schematic diagram of the base-mounted charging system.

Installation takes place on prepared asphalt or concrete surfaces.

The charging system is then mounted and finally installed.

The exact dimensions and weights of the charging system can be found in the corresponding documents in chapter 12.1 *Unit dimensions, page 60* and in chapter 4.3 *Technical specifications, page 19*.

The installation material for fixing is included in the scope of delivery.

1) = The design and number of supply lines depends on the number and equipment of the charging system to be installed. See chapter 4.3 *Technical specifications, page 19*.

5.2.1.1 Fastening the charging system



INFORMATION

The design of the ground anchorage must be adapted to the subsoil condition and/or special local conditions.

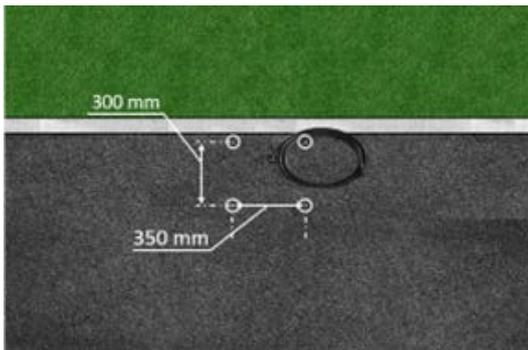
The following description of the assembly is therefore only exemplary. Local conditions are not dealt with in detail. Deviating procedures may only be initiated by competent persons.

Installation requirements

- Ground condition with sufficient load-bearing capacity and evenness
- At least 600 mm lateral free space around the charging system for heat dissipation
- Laid supply line

Installation material and tools

- Depending on ground conditions, 4 suitable ground anchors (e.g. expansion or injection anchors) with threaded bolt M10 or internal thread M10 (not in scope of delivery)
- Suitable drilling tool



1. Drill holes as shown in the drawing using a suitable drilling tool.

⇒ - Drill hole diameter: according to the manufacturer's specification of the ground anchor

⇒ - Drill hole depth: according to the manufacturer's specification of the ground anchor

2. Insert ground anchor according to manufacturer's instructions. Allow injection mortar to harden if used.

3. Insert the supply lines into the charging system from below.

⇒ For alternative supply, close the charging system with a base plate.

4. Place the charging system in the selected position and align it.

Check that no supply lines are crushed!

5. Fasten the charging system with four screws (M 10 x 50).



WARNING

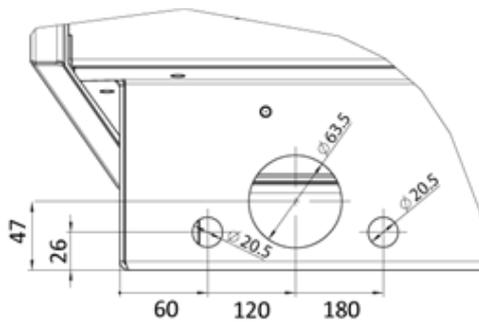
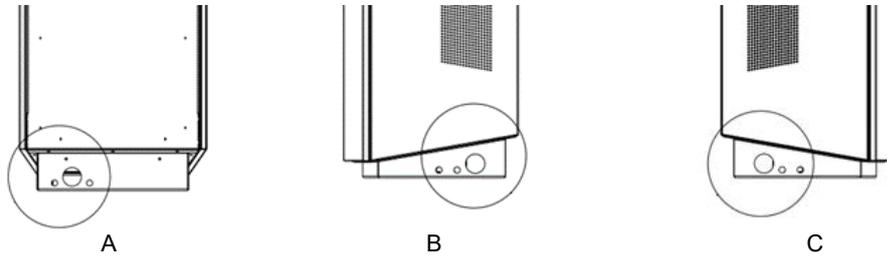
Crushing hazard

Crushing of body parts due to unintentional lowering.

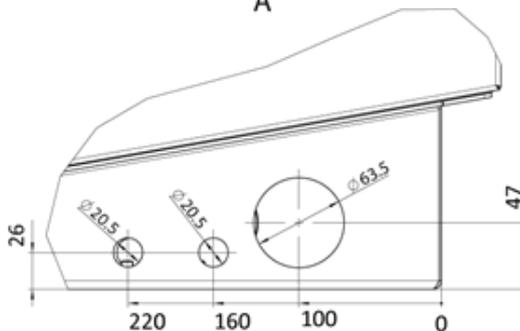
- Body parts must not be under lifted load.

5.2.1.2 Alternative cable routing

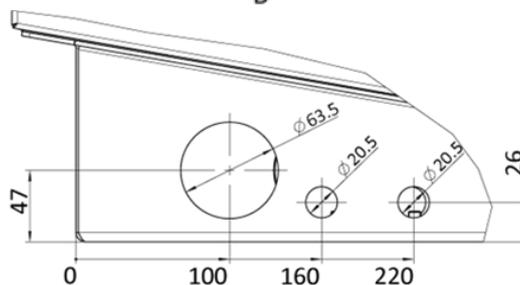
If the supply lines cannot be routed through the bottom of the charging system, they can be fed in at the rear (A), right (B) or left (C) of the unit base.



A



B



C

1. Use a suitable drill to drill additional boreholes into the marked defined area on the sides of the unit.
 - ⇒ Maintain the minimum distance shown between the outer diameters of the individual boreholes.
2. Insert the gland and feed in the supply lines.
 - ⇒ The insertion of the gland and the feeding of the supply cables must not reduce the IP degree of protection and IK degree of protection of the housing.
 - ⇒ The gland must be selected on the basis of the place of use and the expected ambient conditions, paying attention to the temperature, humidity and UV resistance. Waterproof cable glands are recommended.
3. Install strain relief to protect the supply lines from being torn out.



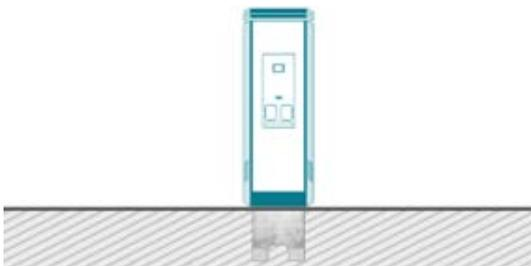
INFORMATION

To protect the charging system, we recommend to install an approach limiter (e.g. bollard).

5.2.2 Installation with concrete base

Installation sequence

1. Select a suitable installation site.
2. Check ground for stability.
3. Check parts and installation material for completeness.
4. Excavation of the installation pit.
5. Lay the supply lines.
6. Compact and level the ground of the excavation pit.
7. Place and align the concrete base.
8. Feed the supply lines through the base.
9. Fix the base by filling.
10. Insert the supply lines through the cable gland of the base plate and into the charging system.
11. Fasten the charging system with installation material.
12. Prepare electrical installation.



The concrete base may only be installed in soils with sufficient load-bearing capacity and condition.

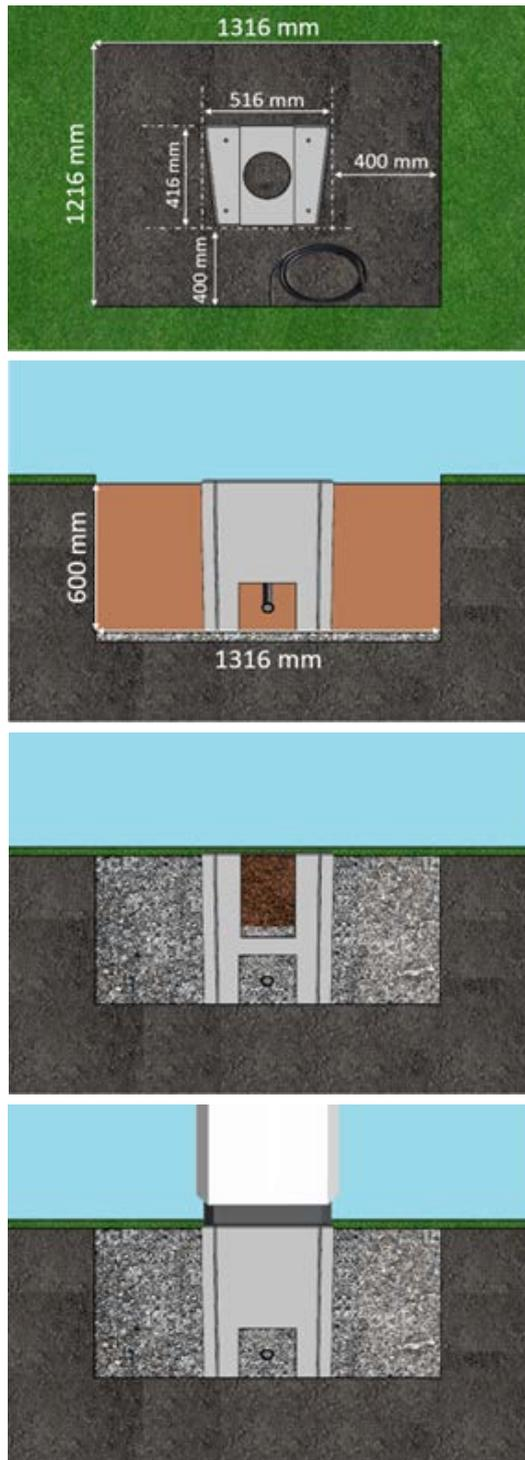
In case of doubt, a qualified civil engineering company must prepare the ground and carry out the installation.

The charging system is then mounted using the fixing material included in the scope of delivery and finally installed.

The exact dimensions and weights of the charging system can be found in the corresponding documents in chapter 4.3 *Technical specifications*, page 19.

Installation requirements

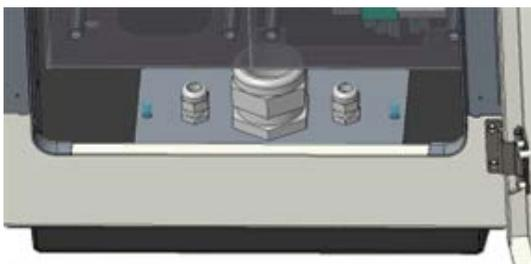
- Ground condition with sufficient load-bearing capacity
- At least 600 mm lateral free space around the charging system for heat dissipation
- Horizontal alignment of the supporting surface
- Base filling material (not in scope of delivery)



Carrying out installation

1. Dig the excavation pit with the following dimensions:
 - ⇒ Width: approx. 1220 mm
 - ⇒ Length: approx. 1320 mm
 - ⇒ Depth: approx. 600 mm
2. If necessary (depending on soil conditions or special local conditions), pour a flat concrete surface. Deepen the excavation pit accordingly.
3. Embed the concrete base into the excavation pit with suitable lifting gear.
 - ⇒ For orientation and alignment, the upper edge of the ground level and the operating side of the charging system are marked on the concrete base
 - ⇒ Concrete base protrudes 20 mm from the ground
4. Insert the supply cable into or through the concrete base.
5. Fill the excavation pit with excavated material.
 - ⇒ Make sure that the filling of the pit reaches the surrounding ground level.
6. Fill the last 300 mm inside the concrete base with concrete base filling material.
 - ⇒ ½ sack of filling material (Compleo)
 - ⇒ The use of the filling material is mandatory as it reduces the penetration of moisture into the charging system from the ground.
7. Compress the excavation material around the charging system.
8. Position and align the charging system over the drilled holes so that the mounting holes of the charging system match the mounting holes in the concrete base.
9. Insert the power supply cable through the cable gland of the base plate into the charging system.
10. Fasten the charging system to the concrete base with four screws (M 10 x 50).
 - ⇒ The installation material is included in the scope of delivery.

5.2.3 Base plate



A base plate is installed inside the charging system. The base plate serves among other things as strain relief.



NOTICE

Electrical hazard due to moisture

Moisture can penetrate the charging system if the base plate is not installed.

- Install the base plate.

5.2.4 Housing closure



A swing lever mechanism is installed in the front door of the housing.

Depending on the version, this is a single or double lock.

1 or 2 profile half-cylinder locks can be installed inside the swivel lever to prevent access by unauthorised persons.

Opening the housing

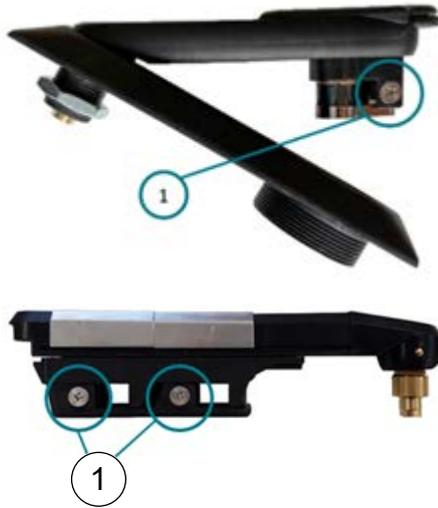
1. Unlock the lock with the associated key.
2. Swing out pivoted lever and turn to the left.
3. Open door to the right.



INFORMATION

If no locking cylinder is installed inside the pivoted lever, the lever can only be opened using a suitable tool (e.g. site key).

5.2.5 Changing the locking cylinder



If necessary, the profile half-cylinder lock can be replaced.

1. Turn the key to the "1 o'clock" position.
2. Unscrew the fixing screw (1) and remove the profile half-cylinder lock.
3. Turn the key in the new profile half-cylinder lock to the "1 o'clock" position.
4. Insert the profile half-cylinder lock at the intended location.
5. Reinsert the fixing screw (1).

5.3 Electrical installation

- For safe disconnection during installation work, disconnect the charging system from the power supply.
 - Switch off the circuit breaker or main switch.

Observe the national legal requirements and regulations during electrical installation. In Germany, these include the following safety requirements:

- DIN VDE 0100-100
- DGUV Regulation 1
- DGUV Regulation 3+4
- TRBS 1201



DANGER

Danger due to electric current

Touching live parts will result in electric shock with serious injury or death.

- Work on electrical components may only be carried out by a qualified electrician and in accordance with electrotechnical regulations.
- Ensure absence of voltage and take suitable protective measures.



NOTICE

Damage to the unit due to high short-circuit current

An incorrectly selected back-up fuse, taking into account the upstream transformer, can result in damage to the unit due to an overly high short-circuit current.

- Select a suitable back-up fuse to reduce the prospective short-circuit current to a maximum of 10 kA.



INFORMATION

This note only applies to charging systems in which the protection technology (MCB) required for the charging point is not installed within the charging system.

- Suitable protection technology must be installed in the upstream sub-distribution.
- The MCB must be selected with a type C tripping characteristic.
- See chapter 4.3 *Technical specifications*, page 19.

**INFORMATION**

This note only applies to charging systems in which the residual current circuit breaker (RCCB) required for the charging point is not installed within the charging system.

- Suitable protection technology must be installed in the upstream sub-distribution.
- The RCCB must comply with the characteristic 40 A/0.03 A, type A.
- See chapter 4.3 *Technical specifications*, page 19.

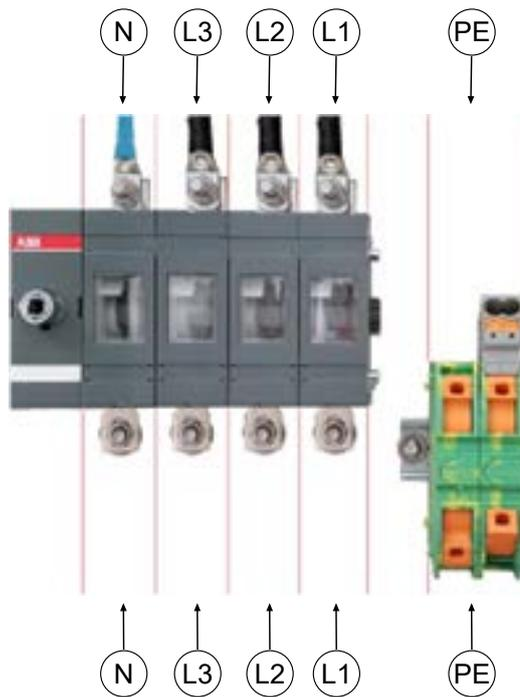
**NOTICE****Unit fault**

Installing an additional RCCB protection device can cause irritation during the automatic self-test for charging systems with built-in RCCB.

Faults and unit failure can be the result.

- If an additional RCCB is required due to installation conditions, the additional RCCB must be selective to the built-in RCCB.

5.3.1 Power supply cable



1. Select the conductor cross-section of the supply cable taking into account the maximum charging capacity, length and installation type.
2. Cut the power supply cable to length so that the cables above the base plate have a length of approx. 300 mm.
3. Strip 30 mm of insulation from the individual wires or according to the cable lugs to be used.
4. Use M8 cable lug. 2 wires can be connected per connection bolt.
5. Connect all conductors of the power supply cable to the external wiring side as shown in the adjacent figure and tighten the screws (M = 20 Nm).
6. Ensure that the individual wires are

correctly connected, the connection bolts/screws are tightened to the specified tightening torque and the connections of the PE terminal are closed correctly (clicked into place).

7. Replace all covers that may have been removed previously.

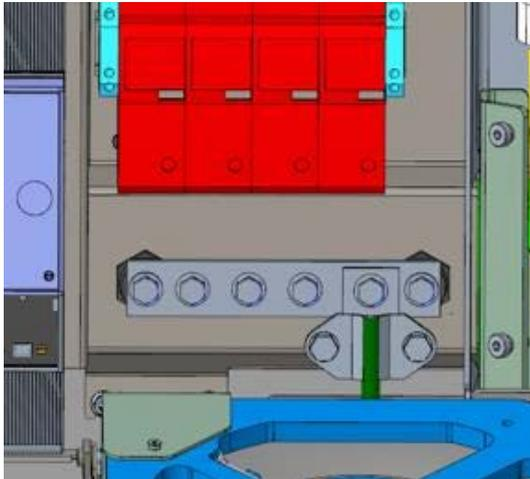


INFORMATION

Aluminium conductors must not be used. Use copper conductors only.

5.3.2 Equipotential bonding

The necessary equipotential bonding is carried out via the permanently mounted equipotential bonding rail in the housing.



1. Select the conductor cross-section of the cable taking into account the maximum length and installation type.
 - ⇒ Ø conductor: max. 35 mm² with M8 compression cable lug, angled at 45°.
2. Cut the wire to length as required, attach and screw the cable ring lugs onto the rail.
 - ⇒ M8 x 20 connection screw; M = 20 Nm.
3. Make sure that the wire is connected correctly and that the clamping screw is tightened according to the specified tightening torque.
4. Replace all covers that may have been removed previously.

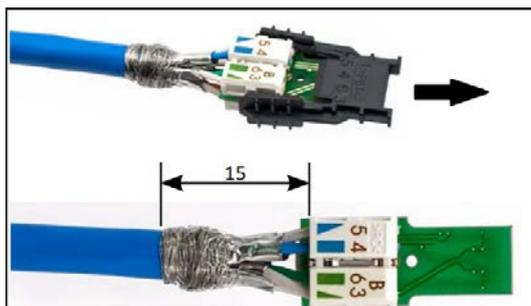
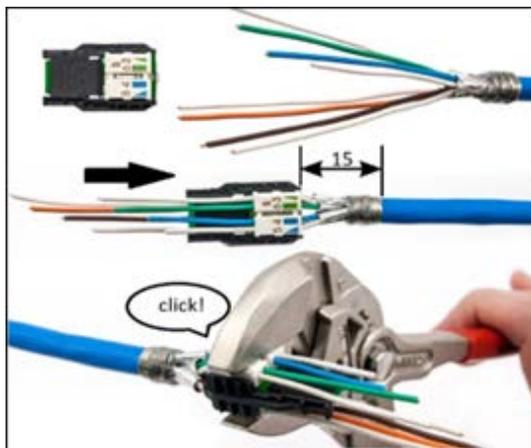
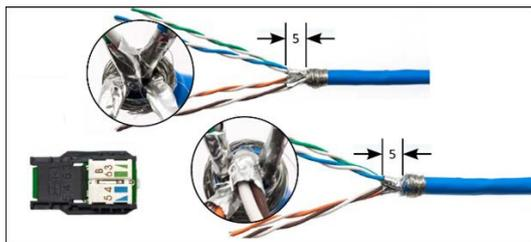
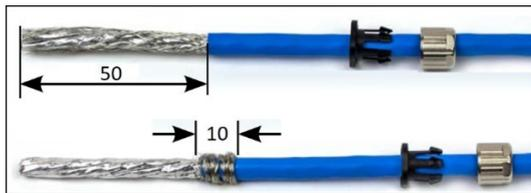
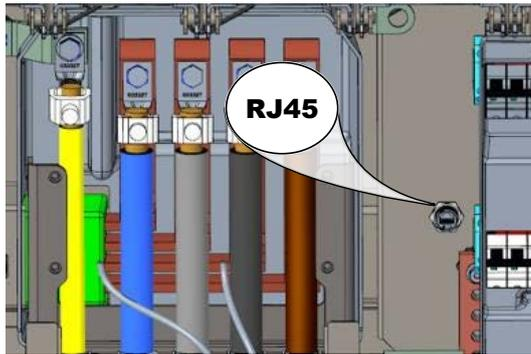


NOTICE

Equipotential bonding connection for surge arresters

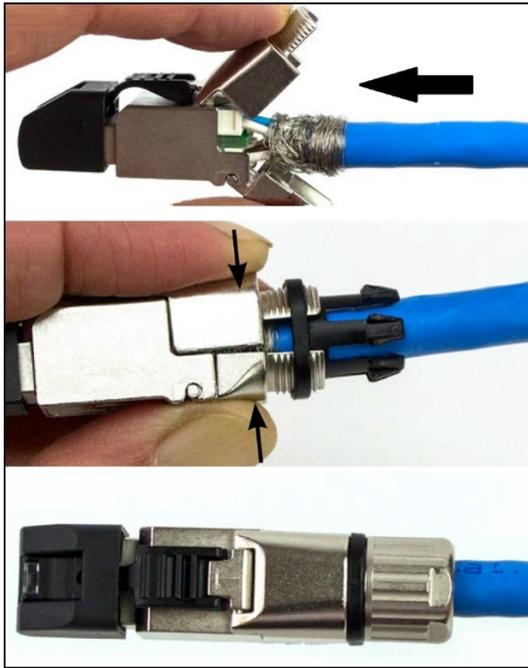
- When connecting a type 1+2 surge arrester, the equipotential bonding connection must be connected to a possibly installed equipotential bonding rail or to a local earth electrode.

5.3.3 Data connection via RJ45 plug



Depending on the equipment of the charging system, the charging system can be connected to an existing network via an internally installed switch using an RJ45 plug and data cable.

1. Strip 50 mm of insulation from the cable as shown in the adjacent figure.
2. Push the strain relief and screw connection of the RJ45 connector housing onto the cable.
3. Wrap the braided shield around the foil shield to a width of 10 mm at the end of the jacket.
4. Remove the foil shield so that it protrudes 5 mm from the jacket.
5. Pre-sort wire pairs to match the colours of the wire manager.
6. Untwist the wire pairs and insert them into the wire manager according to the colour assignment.
7. Grasp the side of the wire manager with suitable pliers and press together until you hear a click.
8. Check the seating of the wire manager.
The distance between the beginning of the wound braided shield and the wire manager must not exceed 15 mm.
9. Cut off the wires protruding from the wire manager flush with an electric side cutter.



10. Remove the black cap from the RJ45 connector housing.
11. Push the wire manager into the RJ45 connector housing.
12. Close the fastener around the wound braided shield.
⇒ Make sure that no strands of the braided shield protrude from the connector.
13. Push the strain relief onto the fastening of the connector.
14. Screw the screw connection to the connector (M = 1 Nm).



NOTICE

The minimum cross-section of the individual strands of the network cable must be below AWG 26. When using a smaller cross-section, it cannot be guaranteed that a connection can be established.

6 Start-up



DANGER

Danger due to electric current

Damage to the charging systems or components may expose live parts. Touching live parts will result in electric shock with serious injury or death.

- Only operate the charging system when it is undamaged.
- In the event of damage, immediately disconnect the charging system from the power supply at the circuit breaker and take suitable safety measures to prevent it from being switched on again.
- Work on electrical components may only be carried out by a qualified electrician.
- Repair work may only be carried out by the customer service.

- Commissioning must be carried out by a qualified electrician or by a person trained and instructed in electrical matters.
- The effectiveness of the protective measures and the correct mechanical and electrical installation must be checked by a qualified electrician prior to commissioning.
- Commissioning may only be carried out when all necessary internal covers are fitted and the housing is completely closed.
- During commissioning, the national legal requirements and technical regulations must be observed.



INFORMATION

The appendix to this manual contains a test report, the test steps of which are derived from the German standards DIN VDE 0100-600 and DIN VDE 0105-100.

Deviating or supplementary national regulations must be observed!

See chapter 12.2 *Commissioning and test reports*, page 61.

6.1 Testing the charging system



The functionality of the installed charging system can be tested either with a vehicle or with a function simulator.

With the function simulator it is possible to simulate the functions of an electric vehicle and check the functionality of a charging system or charging point.

The figure shows an example of a function simulator for testing an AC charging system or AC charging point.

Another suitable test device must be used for all metrological tests.

6.2 System start-up

After the charging system has been correctly installed, the system can be started.

1. Switch on the power supply.
 2. Switch on the line and residual current circuit breaker.
- ⇒ The system starts up.

The duration of the system start-up may vary depending on the type of charging system, configuration and product characteristics. The successful completion of the system start-up is indicated by the status LEDs and the display according to the configuration and product scope of the charging system. The average start-up time is approx. 60 seconds.

A successful system start-up is indicated by the LED of the respective charging point temporarily lighting up green. In the case of a charging system with display, the message "Ready for operation" also appears for the respective charging point.

In addition to the displays mentioned above, the current counter reading and the message "Ready for operation" are shown on the display of any memory and display module (SAM) installed.



INFORMATION

If explicitly requested by the customer, the back-end connections can be configured and tested at the factory. In this case, the back-end connects directly to the associated charging system after applying the operating voltage. This process may take a few minutes.

7 Operation

This chapter explains the general use of the charging system. The charging processes at the charging systems can be started and stopped by different authorisation methods. Depending on the charging system and product scope, the following forms of operation and authorisation are possible:

"Charge for free"

With the "Charge for free" method, a charging process is started or stopped at a charging system without special authorisation. The charging process is started as soon as a charging cable has been connected to the charging system and/or the vehicle. The charging process can only be terminated at the vehicle.

RFID

With the "RFID" method, a charging process is started or stopped at a charging system using a card or chip. The charging process is started as soon as authorisation has been successfully completed and a charging cable has been connected to the charging system and/or the vehicle.

Giro-e:

With the "Giro-e" method, a charging process is started on a charging system by means of a Giro card and then confirmed or terminated. The charging process is started as soon as authorisation has been successfully completed and a charging cable has been connected to the vehicle.

App on smartphone/tablet or website

With the "App on smartphone/tablet or website" method, a charging process is started or ended at a charging system by means of an App or a website.

The App is used to select the charging system, the charging point and the tariff.

The charging process is started as soon as a charging cable has been connected to the vehicle.

The display complying with weights and measures regulations shows an ID number assigned to the charging process.

Depending on the provider, billing takes place via a corresponding payment platform (e.g. PayPal or invoice).

Information on which App is necessary and how to operate the App can be obtained from the operator of the charging system.

Payment terminal:

The charging process is started at a charging system using a debit card, credit card, Google Pay or ApplePay and then confirmed or ended. The charging process is started as soon as authorisation has been successfully completed and a charging cable has been connected to the vehicle.

7.1 Charging process

The charging system is produced in different versions. Depending on the configuration of the charging system, the type of charger interfaces and the procedure for starting a charging process differ.

During charging, the plugs in the charging system and in the vehicle are locked.

If a ventilation function is requested from the vehicle, the charging system interrupts the charging process.

An ongoing charging process can be stopped by executing the authorisation method again.

This is followed by brief instructions on how to start and end a charging process. The brief instructions are divided into variants and differ depending on the type of charger interface and operating method.



DANGER

Danger due to electric current

Damage to the charging systems or components may expose live parts. Touching live parts will result in electric shock with serious injury or death.

- Only operate the charging system when it is undamaged.
- In the event of damage, immediately disconnect the charging system from the power supply at the circuit breaker and take suitable safety measures to prevent it from being switched on again.
- Work on electrical components may only be carried out by a qualified electrician.
- Repair work may only be carried out by the customer service.

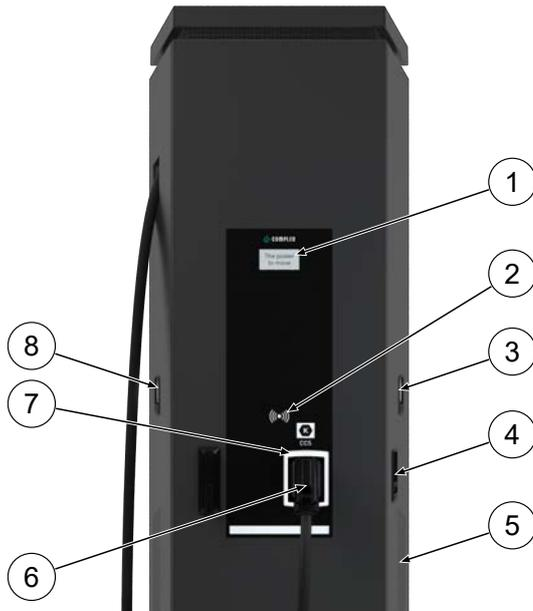
7.2 Charging the vehicle

7.2.1 "Charge for free"

In the factory settings, the charging system is configured to facilitate immediate use and does not require additional settings.

Authorisation can be set up via configuration software if required (see chapter).

7.2.2 Authorisation



- (1) Display (information display)
- (2) RFID field
- (3) SAM AC display and storage module; alternatively: Meter display
- (4) Charging interface, type 2 socket
- (5) Air Inlet
- (6) Charging interface, CCS plug
- (7) Status LEDs
- (8) SAM DC display and storage module; alternatively: Meter display

7.2.2.1 Authorisation via RFID



RFID card or RFID chip

1. Hold the RFID card or RFID chip in front of the RFID field.
 - ⇒ The optional display and the status LED ("green") indicate readiness for operation.

Giro-e

1. Hold the Giro card in front of the RFID field.
 - ⇒ Tariff conditions are shown on the optional display.
2. Hold the Giro card in front of the RFID field again to agree to the conditions.
 - ⇒ The optional display and the status LED ("green") indicate readiness for operation.

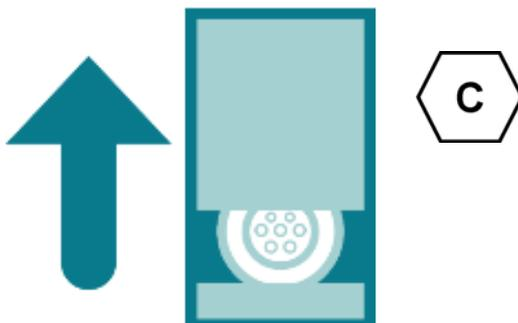
7.2.2.2 Authorisation via App



App on smartphone/tablet or website

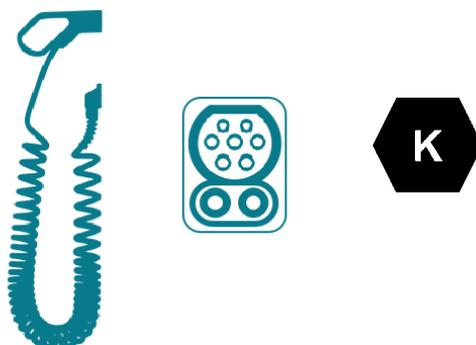
1. Install the App for smartphone or tablet or call up website.
2. Follow the instructions for the authorisation process.
 - ⇒ The optional display and the status LED ("green") indicate readiness for operation.

7.2.3 Charging with type 2 socket



- ✓ The status-LED of the charging point lights up "green".
 1. Plug in the charging cable in the socket of the charging system.
 2. Insert the charging plug into the vehicle's socket.
 - ⇒ The status LED changes from "green" to "blue".
- ⇒ The charging process has started.

7.2.4 Charging with CCS plug



- ✓ The status-LED of the charging point lights up "green".
 1. Insert the charging plug into the vehicle's socket.
 - ⇒ The status LED changes from "green" to "blue".
- ⇒ The charging process has started.

7.3 Ending the charging process

7.3.1 End "Charge for free"



INFORMATION

With the "Charge for free" charging system configuration, the charging process can only be ended at the vehicle.

7.3.2 Authorisation



- (1) Display (information display)
- (2) RFID field
- (3) SAM AC display and storage module; alternatively: Meter display
- (4) Charging interface, type 2 socket
- (5) Air Inlet
- (6) Charging interface, CCS plug
- (7) Status LEDs
- (8) SAM DC display and storage module; alternatively: Meter display

7.3.2.1 Authorisation via RFID



RFID card or RFID chip

1. Hold the RFID card or RFID chip in front of the RFID field again.
 - ⇒ The optional display indicates the end of the charging process.
 - ⇒ The status LED changes from "blue" to "green".
- ⇒ The charging process has ended.



Giro-e

1. Hold the Giro card in front of the RFID field again.
 - ⇒ The optional display indicates the end of the charging process.
 - ⇒ The status LED changes from "blue" to "green".
- ⇒ The charging process has ended.

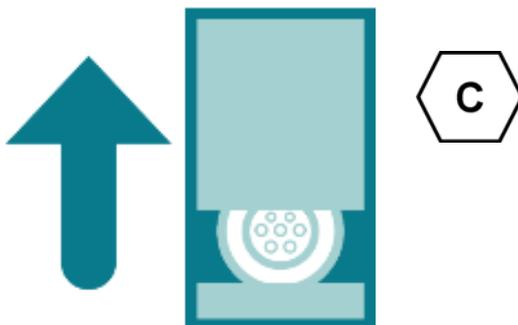
7.3.2.2 Authorisation via App



App on smartphone/tablet or website

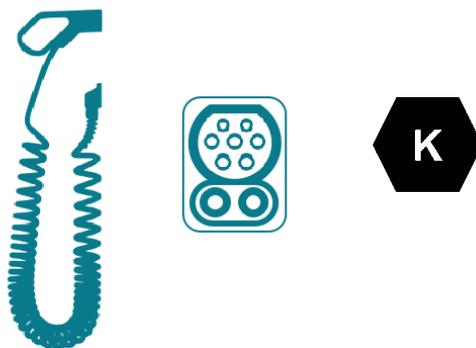
1. Open the App and follow the instructions for ending the charging process.
 - ⇒ The optional display indicates the end of the charging process.
 - ⇒ The status LED changes from "blue" to "green".
- ⇒ The charging process has ended.

7.3.3 Ending charging with type 2 socket



- ✓ The status-LED of the charging point lights up "green".
 1. Pull the charging plug out of the vehicle's socket.
 2. Pull out the charging cable from the socket of the charging system.
 3. The charging system changes to the standby state.
 - ⇒ LED "Off": Authorisation must be given again.
 - ⇒ LED "green": A renewed charging process can be started.

7.3.4 Ending charging with CCS plug



- ✓ The status-LED of the charging point lights up "green".
 1. Pull the charging plug out of the vehicle's socket.
 2. The charging system changes to the standby state.
 - ⇒ LED "Off": Authorisation must be given again.
 - ⇒ LED "green": A renewed charging process can be started.

7.3.5 Retrieve billing data



Giro-e

Within a period of 10 minutes after completion of a charging process, it is possible to display the SEPA ID by holding the Giro card in front of the RFID field again.

**App on smartphone/tablet or web interface**

All charging process data can be called up permanently via an individual link in the reason for payment note of the bank account statement. The essential information of the charging process is visible in the account statement.

7.4 Operating Signals and Displays

7.4.1 Status LED displays

The following charging state display explains the colour states and the possible colour changes of a charging system with status LEDs:

LEDs indicator lights		
	LED: "Off"	<ul style="list-style-type: none"> - The charging system is in standby mode. - Authorisation can be carried out.
	LED: "green"	<ul style="list-style-type: none"> - The charging system indicates readiness for operation. (following successful authorisation). - A charging process can be started.
	LED: "blue"	<ul style="list-style-type: none"> - The charging system indicates a charging process. - The charging process can be maintained or terminated.
	LED: "red"	<ul style="list-style-type: none"> - The charging system indicates an error state. - A charging process cannot be started.

LED colour change		
	LED: "green-blue"	<ul style="list-style-type: none"> - The charging system indicates the start of a charging process.
	LED: "blue-green"	<ul style="list-style-type: none"> - The charging system indicates the end of a charging process.

LED flashing indicator		
	LED: "flashes green"	<ul style="list-style-type: none"> - The charging system is expecting for an action.

7.4.2 Displays



RFID card

- The display and the status LED indicate the start of the charging process.
- Information on the charging process (charging volume, charging data, charging power) is displayed on a scrolling display.
- Tariff information can be found in the charging contract.

Giro-e

- The display and the status LED indicate the start of the charging process.
- Information on the charging process (charging volume, charging data, charging power) and tariff information is displayed on a scrolling display.

7.4.3 Acoustic signals

In the following table the possible acoustic signals are listed and explained:

Acoustic signals	
1 x short	Sounds when the RFID card is presented and indicates "Card read".
2 x short	This signal requires user interaction: <ul style="list-style-type: none"> – Present card for authorisation or – Plug the charging cable into the charging system and car
1 x long	Authorisation timeout: Sounds if user interaction has not occurred within a certain time.
2 x long	The charging system is in an error state. <ul style="list-style-type: none"> – If there is a display, note the error message.

8 Malfunctions

8.1 Residual current circuit breaker (RCCB)

In the event of a residual current, the residual current circuit breaker trips.

To switch on again, proceed as follows:

1. Eliminate the cause of the error.
 2. Reactivate the residual current circuit breaker using the slider on the RCCB.
- ⇒ The charging system is ready for operation again.



INFORMATION

Only applies to charging systems with built-in residual current circuit breaker (RCCB).

8.2 Circuit breaker (MCB)

In the event of an overcurrent, the affected circuit breaker trips and the charging system is switched off.

To switch on again, proceed as follows:

1. Eliminate the cause of the error.
 2. Reactivate the circuit breaker at the sub-distribution.
- ⇒ The charging system is ready for operation again.

9 Troubleshooting information

Charging systems equipped with a display show an error code on the display in the event of an error.

If several errors occur at the same time or in combination, the respective error codes are shown one after the other on the display.

9.1 About this information

Column name	Explanation
Designation	String that is sent to the back-end when the charging station is in online mode.
Abbreviation	Symbol that is shown individually or in combination with other symbols on the display of the charging station depending on the status.
Error clearance information	Description of the error and information on troubleshooting.

9.2 Scope of application

Firmware 5.X and 6.X (SOLO, DUO, CITO)

9.3 OCPP 1.6

Designation	Abbreviation	Error clearance information
GroundFailure	B	The RCD switch, the circuit breaker or the 6mA sensor of the charging point has tripped. Requires inspection by qualified electrician.
InternalError	D	Internal hardware or software component error. Requires inspection by qualified electrician.
OverVoltage	E	The voltage has risen above an acceptable level. Requires inspection by qualified electrician.
PowerMeterFailure	F	Error when reading the meter. Check SAM or meter for correct function and report the malfunction.
PowerSwitchFailure	G	Contactors fault. Requires inspection by qualified electrician.
UnderVoltage	I	The voltage has fallen below an acceptable level. Requires inspection by qualified electrician.
ConnectorLockFailure	-	Error when locking or unlocking the plug. Check whether the plug is properly connected.
OverCurrentFailure	-	The vehicle has drawn more current than specified over a longer period of time.

Unused: EVCommunicationError, HighTemperature, ReaderFailure, WeakSignal

9.4 Compleo-specific

Designation	Abbreviation	Error clearance information
IsolationWarning	K	Insulation problems have occurred before or during a charging process. Requires inspection by qualified electrician.
IsolationError	L	Insulation problems have occurred before or during a charging process. Requires inspection by qualified electrician.
DoorOpen	M	The door contact signals that the door has been opened. Close the door. If this condition is permanent, an inspection by a qualified electrician is required.
DoorClosed	N	The door contact signals that the door has been closed. No action required.
Inoperative	O	The charging point is not available because a resource, such as the power module, is occupied by another charging point. Requires inspection by qualified electrician.
FuseError	P	A circuit breaker switch has triggered. Requires inspection by qualified electrician.
TemperatureSensorMissing	Q	The temperature sensor does not provide any values. Requires inspection by qualified electrician.
AutomaticRcdTestRunning	T	Automatic RCD test is running. No action required.
RCSensorTestRunning	W	Test of the 6mA sensor test is running. No action required.
samTransactionMemoryFull	4	SAM has no more free memory for new charging processes. SAM must be replaced by a qualified electrician.
samEVSEIDMemoryFull	5	SAM has no more free memory for new configuration parameters. SAM must be replaced by a qualified electrician.
samFirmwareCorrupted	6	The SAM firmware checksum check failed. If this condition is permanent, SAM must be replaced by a qualified electrician.

Designation	Abbreviation	Error clearance information
samNoTouchControllerComm	7	The connection to the SAM buttons is faulty. Requires inspection by qualified electrician. If this condition is permanent, SAM must be replaced by a qualified electrician.
samNotInitialized	8	SAM initialisation failed. If this condition is permanent, SAM must be replaced by a qualified electrician.
samInternalError	9	SAM reports an internal error. SAM must be replaced by a qualified electrician.
UnlockPlugFailure	a	The plug could not be unlocked. The locking unit of the charging point must be checked by trained personnel and replaced if necessary.
OutletCloseError	b	The sliding cover could not be closed. The locking unit of the sliding cover must be checked by trained personnel and replaced if necessary.
LPCCommunicationError	c	Communication between the charging point controller and the charging station controller is faulty. The respective connection must be checked by trained personnel and replaced if necessary.
CableError	d	An unauthorised charging cable was detected. Use another charging cable.
RCSensorTestError	e	The 6mA sensor test failed. Requires inspection by qualified electrician.
PowerMonitoringError	f	The charging point controller has detected a mains failure. Requires inspection by qualified electrician.
ADCError	g	The charging point controller has detected an ADC error. Requires inspection by qualified electrician.
ShortCircuitError	h	The charging point controller has detected a short circuit between CP and PE. Requires inspection by qualified electrician.
LPCOverVoltageError	i	The charging point controller has detected an overvoltage. Requires inspection by qualified electrician.
LPCHighTemperatureError	j	The charging point controller has detected a temperature that is too high. Requires inspection by qualified electrician.
LPCSelftestError	k	The self-test of the charging point controller has failed. Requires inspection by qualified electrician.
AutomaticRcdTestFailed	m	The automatic test of the RCD failed. Requires inspection by qualified electrician.

Designation	Abbreviation	Error clearance information
LPCTemperatureSensorError	n	The charge point controller reports a temperature sensor error. Requires exchange by qualified electrician.
CurrentSensorFailure	o	The charge point controller reports current sensor failure. Requires inspection by qualified electrician.
PolarityProtectionError	p	The charge point controller reports that the phases are connected with reversed polarity. Requires inspection by qualified electrician.
samCompensationsParametersMismatch	q	Compensation parameters in SAM and the meter do not match. Requires inspection by qualified electrician.
samCompensationTariffMismatch	r	Selected tariff in the meter does not correspond to the one reported as active by the meter. Requires inspection by qualified electrician.
samMeterIdMismatch	s	The SML ID of the connected meter does not correspond to that of the meter coupled to the SAM. Requires inspection by qualified electrician.
AutomaticRcdTestSuccess	-	Automatic RCD test successful. No action required.
AutomaticRcdTestTripFailure	-	Automatic RCD test failed. Requires inspection by qualified electrician.
AutomaticRcdReset ContactorTestFailed	-	The cause of the failed RCD test has not been rectified. Requires inspection by qualified electrician.
AutomaticRcdResetSuccess	-	The cause of the failed RCD test has been rectified. No action required.
OutletOpenError	-	The socket could not be opened. Requires inspection by qualified electrician.
RCSensorErrorDuringCharge	-	The 6mA sensor triggered during a charging process. Inspection by a qualified electrician is required if the fault occurs frequently.

10 Maintenance

Careful and regular maintenance ensures that the functional condition of the charging system is maintained. Only a regularly checked and maintained charging system is able to guarantee maximum availability and reliable charging processes.

The maintenance intervals depend on the prevailing operating conditions, such as the frequency of use and environmental influences such as the degree of contamination.

We recommend a cyclically recurring inspection according to the maintenance plan. In special cases, the cycles can be shorter.



DANGER

Danger due to electric current

Touching live parts will result in electric shock with serious injury or death.

- Work on electrical components may only be carried out by a qualified electrician and in accordance with electrotechnical regulations.
- Ensure absence of voltage and take suitable protective measures.



WARNING

Danger due to improper maintenance

Improper performance of work can lead to serious injuries and damage to property.

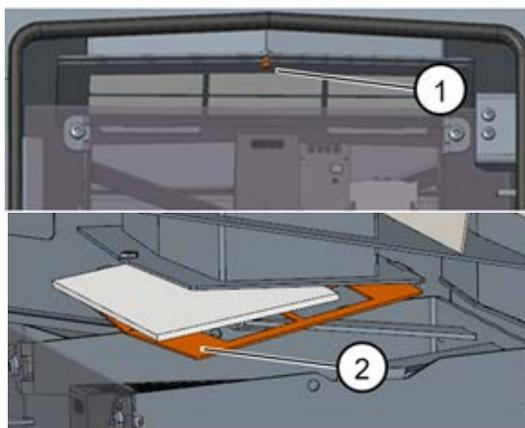
- Only allow work to be carried out by trained specialist personnel.
- Meet all safety requirements before maintenance.

10.1 Maintenance plan

Interval	Component/location	Maintenance work
Every 6 months	Residual current circuit breaker	– Check with test button.
	Surge arrester	– Visual inspection.
Yearly	Location	– Visual inspection, e.g. for distances to objects (bushes, installations ,etc.), attachment.
	Electrical components	– Visual inspection, e.g. cables, lines, screw connections, plugs, RCD, MCB, display, LED, display, surge protection. – Metrological verification according to test report (see chapter 12.2 <i>Commissioning and test reports, page 61.</i>) – Check for function, e.g. RCD, MCB.
	Mechanical components	– Visual inspection, e.g. housing, paint, foils, covers. – Check for function, e.g. sliding cover; parking position.
	Wear parts	– Replace, e.g. filter mats (only for active cooling).
	Charging system	– Check for function, e.g. start and stop of a charging process at all charger interfaces.
As required	Charging system	– Clean the inside and outside of the housing.

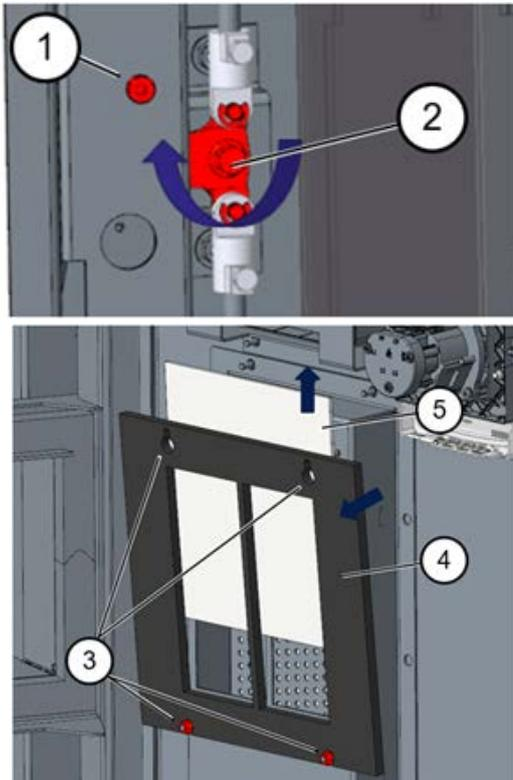
10.2 Maintenance work

10.2.1 Replacing the filter mat at the air outlet



1. Open the door of the charging station.
2. Unscrew the screw on the filter holder (1).
3. Tilt down the filter clamping plate (2) and replace the filter mat.
4. Fold up the filter clamping plate again and screw it tight.
5. Note: The cover need not be removed.

10.2.2 Replacing the filter mat at the air inlet



1. Open the door of the charging station.
2. Unscrew the screw approx. 10 mm (1).
3. Turn the locking lever of the door 90° upwards (2) and open the side door.
4. Loosen the nuts (3), push the filter holder upwards and fold it out (4).
5. Pull out filter mat (5).
6. Replace filter holder together with new filter mat and tighten nuts.
7. Turn the locking lever of the door 90° downwards (2) and close the side door.
8. Screw the screw back in (1) and close the door.

10.3 Maintenance and repair



DANGER

Danger due to electric current

Damage to the charging systems or components may expose live parts.

Touching live parts will result in electric shock with serious injury or death.

- Only operate the charging system when it is undamaged.
- In the event of damage, immediately disconnect the charging system from the power supply at the circuit breaker and take suitable safety measures to prevent it from being switched on again.
- Work on electrical components may only be carried out by a qualified electrician and in accordance with electrotechnical regulations.
- Repair work may only be carried out by the customer service.

Maintenance and repair work may only be carried out by the manufacturer or by specialists authorised by the manufacturer.

1. Replace the charging station if necessary.

10.4 Cleaning

Cleaning may only be carried out by a properly and professionally instructed person and must never be carried out by a user.

Any necessary cleaning of the interior should only be carried out after consultation with the operator of the charging system.

Only materials and dry cleaning agents which are antistatic and do not damage the electrical or mechanical components may be used as cleaning agents for the interior.

Only materials and agents that do not attack or damage the surface of the housing or any applied foiling or paintwork must be used as cleaning agents for the external housing.

If chemical agents are used for cleaning, the activities may only be carried out outdoors or in well-ventilated rooms.



DANGER

Danger due to electric current

Touching live parts will result in electric shock with serious injury or death.

- Only clean the charging system when it is switched off.
- Do not clean the outer housing with water jets, e.g. with a hose or a high-pressure cleaner.
- Do not clean the interior of the charging system with liquid cleaning agents.
- Do not clean any plugs in the charging system.



WARNING

Damage to the unit

Environmental influences due to rain, splash water or heavy dust exposure on exposed installation components without an installation cover cause damage to the unit.

- Do not leave the charging system unattended with the installation cover open.

11 Decommissioning, dismantling and disposal

The decommissioning and dismantling of the charging system may only be carried out by a qualified electrician.

The national legal requirements and regulations must be observed.



DANGER

Danger due to electric current

Touching live parts will result in electric shock with serious injury or death.

- Work on electrical components may only be carried out by a qualified electrician and in accordance with electrotechnical regulations.
- Ensure absence of voltage and take suitable protective measures.

1. . Finish charging processes properly.
2. . Disconnect the charging system from the power supply.
 - Activate using the internally installed safety elements such as MCB, RCD and any installed main switch.
 - Release the upstream fuse element of the charging system.

Dismantling may only be carried out after it has been established that no voltage is present and suitable protective measures have been taken.

11.1 Disposal

The unit contains materials that can be recycled. To protect the environment and human health, disposal must be carried out in accordance with the laws of the country and the existing take-back organisations.

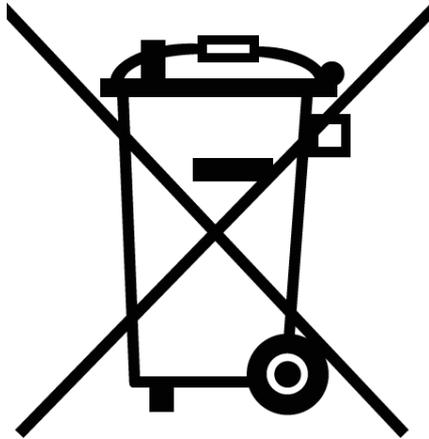
- Observe the requirements of the WEEE Directive 2012/19/EU.
- Dispose of the unit accordingly only via the take-back organisation.
- Dispose of dismantled components only via the take-back organisation.



NOTICE

Incorrect or negligent disposal causes environmental pollution.

- If you have any questions about environmentally friendly disposal, ask your specialist dealer or the manufacturer for information.



Disposal instructions

The symbol with the crossed-out dustbin indicates that this electrical or electronic appliance must not be disposed of with household waste at the end of its service life.

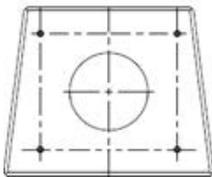
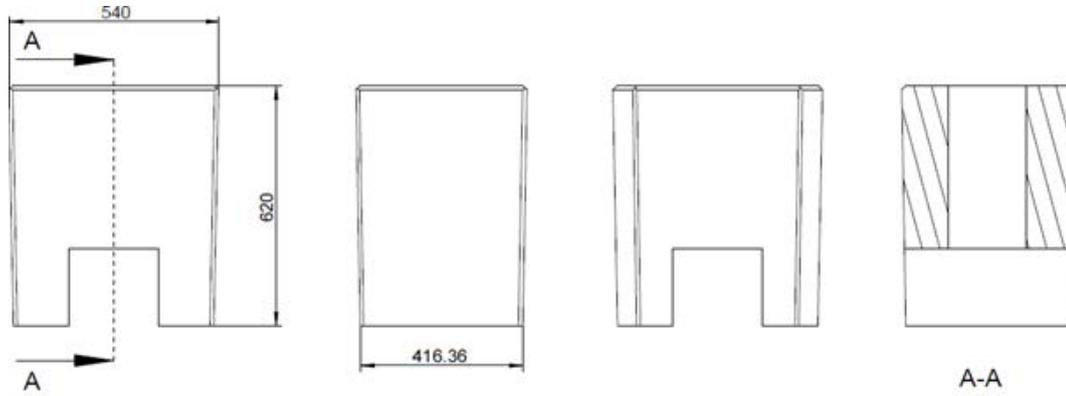
To return the product, contact the manufacturer or dealer.

The separate collection of Waste from Electrical and Electronic Equipment (WEEE) is intended to enable the reuse, recycling or other forms of recovery of WEEE and to avoid negative consequences on the environment and human health from the disposal of hazardous substances that may be contained in the equipment.

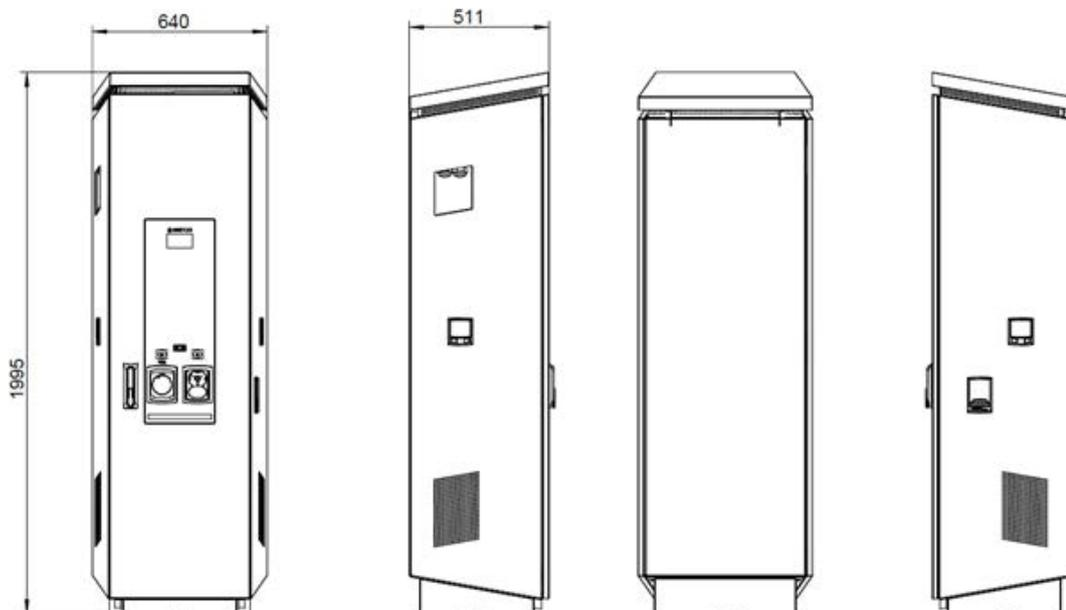
12 Annexes

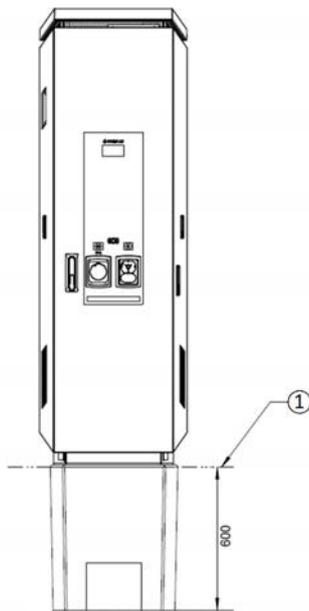
12.1 Unit dimensions

Base



Charging system



Base mounting**12.2 Commissioning and test reports****See also**

 DC-Prüfprotokoll_V1.9 [[▶ 62](#)]

Commissioning and test report for DC charging systems

Applicable for DC charging systems with **combined** operating and power unit (**one housing**):

Operator of the system:

Company/name:

Street:

Post code/town:

Telephone number:

Testing company:

Company/name:

Street:

Post code/town:

Telephone number:

Location of the system:
Date:
 Initial commissioning: according to DIN VDE 0100-600 (2017:06)

 Periodic inspection: according to DIN VDE 0105-100 (2015:10)

Deviating or supplementary national regulations must be observed!

1 General information

Pre-installation carried out by customer	<input type="checkbox"/> yes	<input type="checkbox"/> no
Pre-installation documentation available (pre-installation protocol)	<input type="checkbox"/> yes	<input type="checkbox"/> no

Designation of the test item:			
Serial number:			
Expiration of the calibration period (for version in compliance with calibration law)	KW/year		
Network form:	<input type="checkbox"/> TT	<input type="checkbox"/> TN-S	<input type="checkbox"/> TN-C
Local earthing available	<input type="checkbox"/> yes	<input type="checkbox"/> no	
Lightning protection concept recognisable at the site	<input type="checkbox"/> yes	<input type="checkbox"/> no	Point out the necessity to the operator!

1.1 Equipment-dependent specifications

Component	Not installed	Serial number	Counter reading in kWh
Charging point counter 1	<input type="checkbox"/>		
Charging point counter 2	<input type="checkbox"/>		
Component	Not installed	Type designation(s)	Comments
Overvoltage protection HMI	<input type="checkbox"/>		

2 Work before initial commissioning

INFO: Cut the cable insulation to length according to the installation instructions (failure to do so may result in a **FIRE HAZARD**)

Check of the cable glands (torque) and tensile test on cables in a de-energised state carried out? **Yes**
 No

2.1 Measuring and testing equipment used

Manufacturer	Designation	Serial number	Next calibration

3 Visual inspections

External visual inspection	Control panel (HMI)		Comments
	OK	NOK	
Housing condition	<input type="checkbox"/>	<input type="checkbox"/>	
Contamination	<input type="checkbox"/>	<input type="checkbox"/>	
Display disc counter/SAM	<input type="checkbox"/>	<input type="checkbox"/>	
Display disc controller	<input type="checkbox"/>	<input type="checkbox"/>	
Charging cable CCS	<input type="checkbox"/>	<input type="checkbox"/>	In the event of damage: Replacement only by certified repairer! (Conformity with law on weights and measures must be checked)
Charging cable CHAdeMO	<input type="checkbox"/>	<input type="checkbox"/>	
Charging socket AC	<input type="checkbox"/>	<input type="checkbox"/>	
Ram protection (if available)	<input type="checkbox"/>	<input type="checkbox"/>	

Internal visual inspection	Control panel (HMI)		Comments
	OK	NOK	
Components (RCD, contactor, MCB,...)	<input type="checkbox"/>	<input type="checkbox"/>	
Cabling	<input type="checkbox"/>	<input type="checkbox"/>	e.g. cable gland
General level of contamination	<input type="checkbox"/>	<input type="checkbox"/>	
Filter contamination level	<input type="checkbox"/>	<input type="checkbox"/>	
Humidity	<input type="checkbox"/>	<input type="checkbox"/>	
Corrosion	<input type="checkbox"/>	<input type="checkbox"/>	
Overvoltage protection (if available)	<input type="checkbox"/>	<input type="checkbox"/>	Visual display = green
Base filler applied	<input type="checkbox"/>	<input type="checkbox"/>	
Covers for active parts	<input type="checkbox"/>	<input type="checkbox"/>	

4 Metrological inspection (to be carried out once a year)

Test	Individual measurements	Limit value	Measured value	Comments	
Continuity of protective conductor	CCS	Low impedance Recommendation : <1Ω	Ω	Measurement from charging cable/charging socket to charging station feed-in	
	Type 2		Ω		
Equipotential bonding	Main equipotential bonding rail	Low impedance	Ω	Recommendation: <1Ω	
Insulation resistance without consumer (from supply point of charging system to charging plug, with fixed cable or charging socket)	L1-PE	≥1.0MΩ	MΩ	For charging systems with two charging points, disconnect one charging point by switching off one MCB and measure the other side before starting the measurement, then repeat this procedure on the other side. VDE 0100-600 Section 6.4.3.3 Reduce the measuring voltage to 250V when testing the active conductors with each other and repeat the test if Riso <1MΩhm	
	L2-PE		MΩ		
	L3-PE		MΩ		
	N-PE		MΩ		
	L1-L2	≥1.0MΩ	MΩ		
	L2-L3		MΩ		
	L1-L3		MΩ		
	L1-N		MΩ		
	L2-N		MΩ		
L3-N	MΩ				
Mains voltage	L1-N	230V	V		
	L2-N	+/-10%	V		
	L3-N		V		
	L1-L2	400V	V		
	L2-L3	+/-10%	V		
	L1-L3		V		
Rel. voltage drop (calc. meas.)	<input type="checkbox"/> OK <input type="checkbox"/> NOK	Max. 5% up to supply point		Measurement of NSV - supply point output	
Error loop impedance Z_s	TN network	L1-PE	$Z_s \leq \frac{U_0}{I_a}$ U_0 = nominal AC voltage I_a = trip current (MCB/RCD)	<input type="checkbox"/> OK <input type="checkbox"/> NOK	VDE 0100-600 Section 6.4.3.7.1 Note 1: If residual current devices (RCDs) with $I_{\Delta N} \leq 500 \text{ mA}$ are used as shutdown devices, measurement of the fault loop impedance is generally not required.
		L2-PE		<input type="checkbox"/> OK <input type="checkbox"/> NOK	
		L3-PE		<input type="checkbox"/> OK <input type="checkbox"/> NOK	
	TT network	L1-PE	$Z_s \leq \frac{50V}{I_{\Delta N}}$ $I_{\Delta N}$ = rated differential current in A of the RCD	<input type="checkbox"/> OK <input type="checkbox"/> NOK	
		L2-PE		<input type="checkbox"/> OK <input type="checkbox"/> NOK	
		L3-PE		<input type="checkbox"/> OK <input type="checkbox"/> NOK	

		N-PE		<input type="checkbox"/> OK <input type="checkbox"/> NOK		
Residual current device RCD and DC sensor	AC Residual current, sinusoidal	Trip current $I_{\Delta N}=30\text{mA}$	$>15 \leq 30\text{mA}$		mA	
		Trip time $1x I_N$	$<300\text{ms}$		ms	
		Trip time $5x I_N$	$<40\text{ms}$		ms	
	DC (6mA sensor = pos. and neg. edge RCD type B = rising DC residual current)	Trip current $I_{\Delta N}=30\text{mA}$	$>3 \leq 6\text{mA}$ for 6mA sensor $\leq 60\text{mA}$ for RCD type B		Pos. edge	mA
					Neg. edge	mA
		Trip time	$<10\text{s}$ for 6mA $< 0.3\text{s}$ for type B		Pos. edge	S
			Neg. edge	S		

5 Functional tests

Test	Control panel (HMI)		Comments
	OK	NOK	
Charging process CCS	<input type="checkbox"/>	<input type="checkbox"/>	
Charging process CHAdeMO	<input type="checkbox"/>	<input type="checkbox"/>	
Charging process AC	<input type="checkbox"/>	<input type="checkbox"/>	
Closing mechanism	<input type="checkbox"/>	<input type="checkbox"/>	
Function test button RCD	<input type="checkbox"/>	<input type="checkbox"/>	Inspection every 6 months according to manufacturer
HRA tripping (hardware redundant shutdown)	<input type="checkbox"/>	<input type="checkbox"/>	Charging station in StandBy → Operate contactor AC charging point → RCD must trip
Parking position lighting	<input type="checkbox"/>	<input type="checkbox"/>	
RFID reader lighting	<input type="checkbox"/>	<input type="checkbox"/>	
Ambient lighting	<input type="checkbox"/>	<input type="checkbox"/>	
Insulation monitoring device Version: 1. Check with vehicle simulator with IMD test equipment, or 2. Check with separate resistance bridge	<input type="checkbox"/>	<input type="checkbox"/>	DC+ against PE
	<input type="checkbox"/>	<input type="checkbox"/>	DC- against PE

6 Additional work

Description	Completed	Not completed	Comments
Filter mat cleaning	<input type="checkbox"/>	<input type="checkbox"/>	
Filter mat replacement	<input type="checkbox"/>	<input type="checkbox"/>	

7 Result:

Test results	Yes	No
All tests were carried out	<input type="checkbox"/>	<input type="checkbox"/>
Defects present	<input type="checkbox"/>	<input type="checkbox"/>
Defect eliminated	<input type="checkbox"/>	<input type="checkbox"/>
Inspection tag attached	<input type="checkbox"/>	<input type="checkbox"/>

Comments:
Next test date on:
Place, date:
Tester: First and last name in block capitals
Signature:

12.3 Memory and display module SAM

See also

 [SAM_EU_rev05.pdf](#) [▶ 68]

Operating instructions

SAM EU

Memory and Display Module

Article number: SAM EU en



1	About this manual.....	3
2	SAM product description.....	5
2.1	Product information.....	5
2.2	Intended use	6
2.3	Controls and display.....	6
2.4	Type and rating plates.....	7
2.5	Overview of all displays (examples)	8
2.5.1	Overview of all displays (examples).....	10
2.5.2	Overview of all displays (examples).....	13
2.6	SAM system overview	18
2.7	Integration of the subsystem in a charging column	19
2.8	Communication connections	20
2.9	Power supply.....	20
2.10	SAM module system overview	20
2.11	Time measurement of the charging service duration (stopwatch function)	22
3	Charging process with SAM	26
3.1	Readiness	26
3.2	Authorisation	26
3.3	Two seconds until charging.....	27
3.4	Charging process	27
3.5	End of the charging process	28
4	Query previous charging processes with SAM.....	29
4.1	Query via backend.....	29
4.2	Query on site.....	29
5	Technical data.....	35
5.1	Measuring capsule	35
5.2	Accuracy of the charging equipment	35
6	SAM installation.....	36
6.1	Connections	36
6.2	Connection of SAM and meter.....	37

1 About this manual

These instructions will enable you to handle your product safely and efficiently.

Safety

Before attempting to install or operate the product you have purchased, read the operating instructions carefully to familiarise yourself with the product.

These instructions are intended for qualified personnel only. These are persons who, due to their technical training and knowledge of the relevant standards, are able to assess the work assigned and recognise possible hazards.

The basic prerequisite for safe working is compliance with all the safety instructions and handling instructions given in these instructions. In addition, the local accident prevention regulations and the general safety regulations for the application area of the product apply.

The illustrations in these instructions are for basic understanding and may differ from the actual design.

In addition to these instructions, the local legal regulations for connection to the local low-voltage network of a grid operator or the technical regulations of the trade associations apply.

Validity

These instructions reflect the state-of-the-art of the product at the time of publication. The contents of these instructions are not the subject of a contract, but are for information purposes. Compleo Charging Solutions AG reserves the right to make changes to the content and technical specifications of these instructions without having to disclose them. Compleo Charging Solutions AG cannot be held responsible for any inaccuracies or unsuitable information in these instructions that have arisen due to changes in content and technology after delivery of the product, as there is no obligation to update these instructions on an ongoing basis.

Warranty

Our deliveries and services are based on the general terms of delivery for products of the electrical industry as well as our general terms of sale. The information in these instructions, in particular the technical data, operation, dimensions and weights, are subject to change at any time.

Handling

These instructions are organised so that all work necessary for operation and use can be carried out by suitably qualified personnel.

In order to clarify and facilitate the necessary work, images are assigned to certain processing steps. If hazards to persons and material cannot be excluded for certain work, these activities are identified by certain pictograms. Their meaning can be found in the Safety Instructions chapter.

Storing the instructions

Also keep these instructions in a suitable place for future reference.

Hand out these instructions with the unit when changing operators.

Abbreviations

Abbreviation	Explanation
AC	Alternating Current
AP	Delivery point
CCS	Plug designation for: Combined Charging System
CHA	Abbreviation for plug designation: CHAdeMO
CPO	Charge Point Operator
CRC	Cyclic Redundancy Check
DC	Direct Current
EMC	Electromagnetic Compatibility
EVSEID	Electric Vehicle Supply Equipment
HMI	Human-Machine Interface
HW	Hardware
ID	Identification Number
IR	Infrared
kWh	Kilowatt hour
LCD	Liquid Crystal Display
LES	Charging device controller
LIEF	Energy supplier
LS	Charging station
LV	Charging process
MessEG	Measuring and calibration law
MessEV	Measuring and calibration regulations
MSB/MDL	Metering point operators/ metering service providers
MSP/ EMSP	(Electric) Mobility Service Provider
OCPP	Open Charge Point Protocol
RTC	Real-Time Clock
S/N	Serial number
SAM	Memory and display module
SML	Communication protocol Smart Message Language
SW	Software
VNB	Distribution system operator

2 SAM product description

SAM is the memory and display module that permanently stores the start and final meter reading of the charging processes and displays them on request.

2.1 Product information

SAM, in combination with a verified meter, fulfils the possible requirements of the local calibration law when charging an electric vehicle at a charging station.

The unit offers advantages for several market participants:

User:

- Verified billing of kWh and charging time
- SAM is visible to the user at the charging point from the outside and enables a comparison of the meter values on site and on the bill
- Checking of the meter values by the user is possible without additional devices (e.g. computer, internet access, etc.)
- - The displayed values are binding in case of dispute

Charging station operator:

- Significant reduction of complexity in the system compared to alternative solutions ("keep it simple")
- - SAM is a cross-market solution: It is roaming-capable from the start and offers independence from CPO, MSP, backend
- No additional technical requirements for the CPO backend system and downstream data transfer (e.g. communication, storage, transparency software, etc.)
- OCPP 1.5 ff can be used unchanged, no transmission of signed meter values is required
- - All data relevant to the bill is transferred to the backend via OCPP and is available to all market participants
- One-off costs for procurement - no running costs

2.2 Intended use

The SAM is used to collect, store, display and verify meter reading and customer identification data for charging points in charging stations for electric vehicles. One SAM is used per charging point. The SAM is a measuring capsule and consists of the display & storage module and an electronic energy meter. It displays the determined data and stores it permanently in the device itself.

The SAM is designed for mounting on a wall or for a charging station and is to be installed weather protected. The intended use of the product also includes compliance with all the information in these instructions. Any use beyond the intended use or any other use is considered misuse.

The specified ambient conditions for this product must also be observed in all cases (see also chapter "Technical data"). The SAM has been designed, manufactured and tested in compliance with the relevant safety standards.

If the safety instructions are observed and the product is used as intended, there is normally no risk of damage to property or to the health of persons.

Failure to observe the instructions contained in this manual may create sources of danger or render safety devices ineffective. Furthermore, the local safety and accident prevention regulations must be observed for the respective application.

The chapter "Responsibility of the network operator with SAM" must also be observed.

2.3 Controls and display

The following figure shows an assignment of the main components of the SAM.

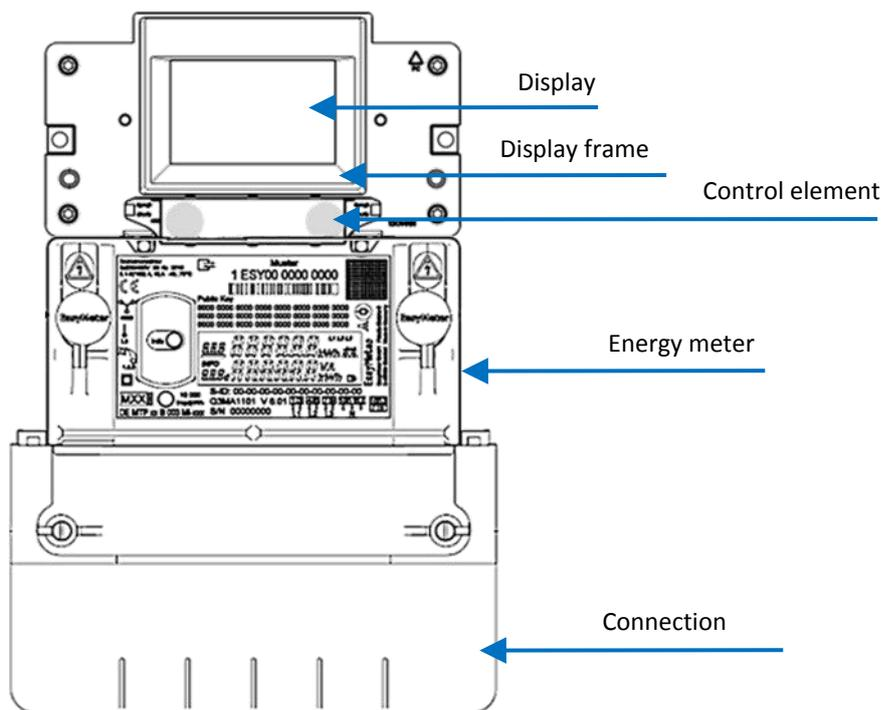


Figure 1: SAM overview image (example)

- Display:** Used to display customer information about the current charging process and to display historical charging processes.
- Display frame:** Labelled with type-related data.
- Control element:** The SAM can be operated via two keys.
- Energy meter:** Used to measure the electrical energy drawn.
- Connection cover:** The connection terminals for the mains connection and charging current are located behind the connection cover.

2.4 Type and rating plates

The SAM type plate and meter rating plate are listed below. Typically, the SAM type plate is visible from the outside (view of the charging station) and the meter rating plate is not.

Type plate of the SAM

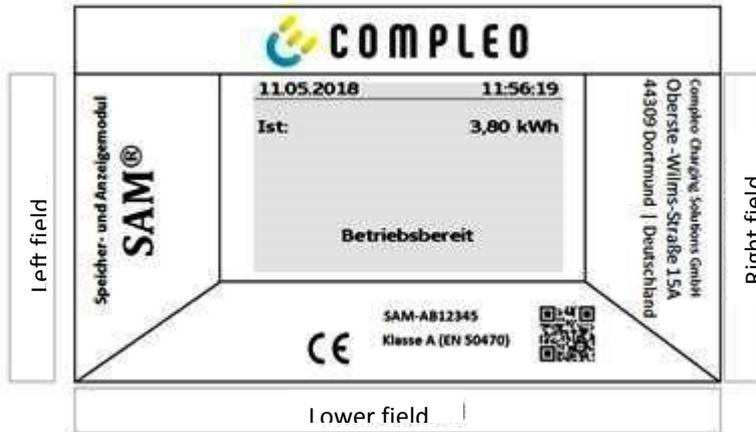


Figure 2: Type plate of the SAM (example)

Display frame: Labelled with

- Upper field: Company logo
- Left field: Product name
- Right field: Manufacturer's address
- Lower field:
 - Metrology marking incl.
 - production year
 - Notified body
 - CE marking
 - Type designation SAM incl. serial number/type key (can be used for HW identification)
 - QR code (contains the type designation and serial number)
 - Accuracy classification

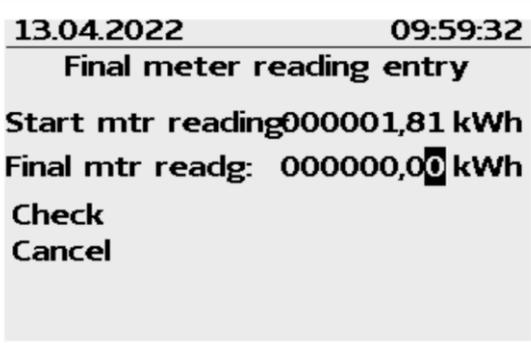
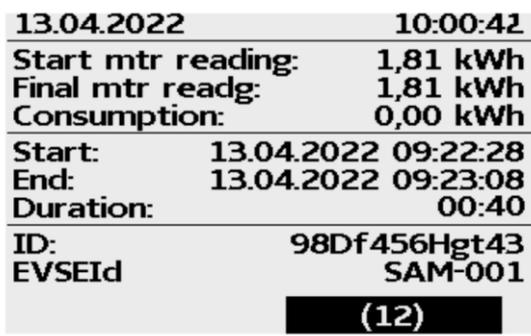
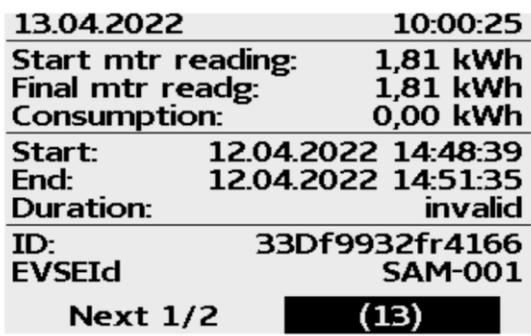
Rating plate of the meter

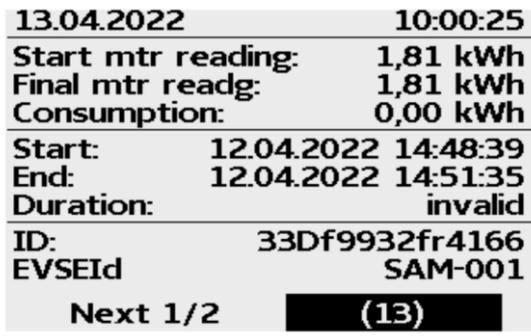
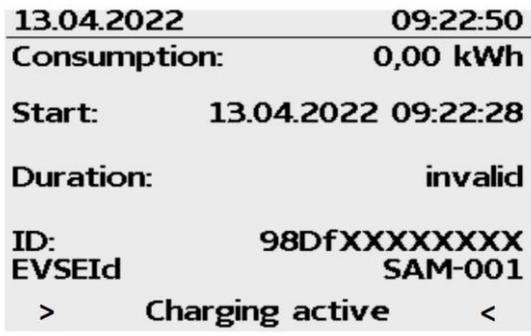


Figure 3: Rating plate of the meter (example)

2.5 Overview of all displays (examples)

Info screens (without interaction with the user)	
<p>Compleo CS - SAM</p> <p>SAM S/N: SAM-AA11112 Meter S/N: 1 ESY11 61132767 HW: V1.0 SW: V1.4.4-dirty Checksum: 0x6A72 Production date: 04.03.2022 charge possible: 65462</p>	<p>19.12.2021 07:54:22</p> <p>TYP2: Right126 CCS5 12345</p> <p>Ready for operation</p>
<p>Boot screen</p>	<p>Ready for operation (idle state)</p>
<p>13.04.2022 09:22:12</p> <p>ID: 98Df456Hgt43 TYP2: SAM-001</p> <p>Ready for operation</p>	<p>13.04.2022 09:22:12</p> <p>ID: 98Df456Hgt43 TYP2: SAM-001</p> <p>Ready for operation</p>
<p>Display of the ID after a successful authorisation.</p>	<p>2 second progress bar (from left to right) until the timing starts.</p>
<p>13.04.2022 09:22:28</p> <p>Consumption: 0,00 kWh Start: 13.04.2022 09:22:28 Duration: 00:00:01.5 ID: 98Df456Hgt43 EVSEId SAM-001 >>> Charging active <<<</p>	<p>13.04.2022 09:22:50</p> <p>Consumption: 0,00 kWh Start: 13.04.2022 09:22:28 Duration: invalid ID: 98DfXXXXXXXXXX EVSEId SAM-001 > Charging active <</p>
<p>Current measured values. The number of arrow symbols represent the number of loaded phases.</p>	<p>After a few seconds, the last digits of the ID are substituted.</p>
<p>13.04.2022 09:22:50</p> <p>Consumption: 0,00 kWh Start: 13.04.2022 09:22:28 Duration: 00:00:25 ID: 98DfXXXXXXXXXX EVSEId SAM-001 Charging active</p>	<p>13.04.2022 10:00:42</p> <p>Start mtr reading: 1,81 kWh Final mtr readg: 1,81 kWh Consumption: 0,00 kWh Start: 13.04.2022 09:22:28 End: 13.04.2022 09:23:08 Duration: 00:40 ID: 98Df456Hgt43 EVSEId SAM-001 (12)</p>
<p>Display of duration with tenths of seconds, only in the first minutes after the start.</p>	<p>Summary at the end of the charging process.</p>

Interactive screen displays with the user to invoke charging procedures.	
	
<p>After entering the start value, press "Next" to enter the final value. (Called up after touching one of the two buttons).</p>	<p>After entering the final value, press "Check".</p>
	
<p>Screen output for a found entry.</p>	<p>If there are several data sets (possible with a charge of ≤ 0Wh), scrolling is possible.</p>

Possible information screens	
	
<p>"Invalid" notice in the charging process summary if there was a communication problem. The data set is not billable according to time!</p>	<p>Notice if there was a communication problem during the charging process. The data set is not billable according to time!</p>

Possible error screens	
<p>19.12.2021 07:54:27</p> <p>Limited operation</p> <p>Billing not possible on basis of measured values</p> <p>Data query possible</p>	<p>19.12.2021 07:54:12</p> <p>Billing not possible based on the measured values</p>
<p>Error message: there is a communication or memory problem.</p>	<p>Error message: there is an internal fault in the SAM.</p>
<p>19.12.2021 07:53:47</p> <p>Entry not found</p> <p>Renewed</p> <p>Cancel</p>	<p>19.12.2021 07:53:47</p> <p>Entry not found</p> <p>Renewed</p> <p>Cancel</p>
<p>Error message: no entry was found. Billing is only possible with a data set that complies with calibration law!</p>	<p>Error message: the data set found is inconsistent. The data set does not comply with calibration law and is therefore cannot be billed!</p>

Lock screen	
<p>19.12.2021 07:54:32</p> <p>Data verification blocked</p> <p>Next check option in 13 seconds</p> <p>Ok</p>	
<p>Lock screen after 5 incorrect queries/entries</p>	

2.5.1 Overview of all displays (examples)

<p>Info screens (without interaction with the user)</p>

<p style="text-align: center;">Compleo CS - SAM</p> <p>SAM S/N: SAM-AA11112 Meter S/N: 1 ESY11 61132767 HW: V1.0 SW: V1.4.4-dirty Checksum: 0x6A72 Production date: 04.03.2022 charge possible: 65462</p>	<p style="text-align: right;">19.12.2021 07:54:22</p> <p>TYP2: Right126 CCS5 12345</p> <p style="text-align: center;">Ready for operation</p>
<p style="text-align: center;">Boot screen</p>	<p style="text-align: center;">Ready for operation (idle state)</p>
<p style="text-align: right;">13.04.2022 09:22:12</p> <p>ID: 98Df456Hgt43 TYP2: SAM-001</p> <p style="text-align: center;">Ready for operation</p>	<p style="text-align: right;">13.04.2022 09:22:12</p> <p>ID: 98Df456Hgt43 TYP2: SAM-001</p> <div style="background-color: black; height: 15px; width: 100%;"></div> <p style="text-align: center;">Ready for operation</p>
<p>Display of the ID after a successful authorisation.</p>	<p>2 second progress bar (from left to right) until the timing starts.</p>
<p style="text-align: right;">13.04.2022 09:22:28</p> <p>Consumption: 0,00 kWh Start: 13.04.2022 09:22:28 Duration: 00:00:01.5 ID: 98Df456Hgt43 EVSEId SAM-001 >>> Charging active <<<</p>	<p style="text-align: right;">13.04.2022 09:22:50</p> <p>Consumption: 0,00 kWh Start: 13.04.2022 09:22:28 Duration: invalid ID: 98DfXXXXXXXXXX EVSEId SAM-001 > Charging active <</p>
<p>Current measured values. The number of arrow symbols represent the number of loaded phases.</p>	<p>After a few seconds, the last digits of the ID are substituted.</p>
<p style="text-align: right;">13.04.2022 09:22:50</p> <p>Consumption: 0,00 kWh Start: 13.04.2022 09:22:28 Duration: 00:00:25 ID: 98DfXXXXXXXXXX EVSEId SAM-001 Charging active</p>	<p style="text-align: right;">13.04.2022 10:00:42</p> <p>Start mtr reading: 1,81 kWh Final mtr readg: 1,81 kWh Consumption: 0,00 kWh Start: 13.04.2022 09:22:28 End: 13.04.2022 09:23:08 Duration: 00:40 ID: 98Df456Hgt43 EVSEId SAM-001 <div style="background-color: black; color: white; padding: 2px; display: inline-block;">(12)</div></p>
<p>Display of duration with tenths of seconds, only in the first minutes after the start.</p>	<p>Summary at the end of the charging process.</p>
<p>Interactive screen displays with the user to invoke charging procedures.</p>	

<p>13.04.2022 09:58:41 Start meter reading entry Start mtr reading 000000,00 kWh Next Cancel</p>	<p>13.04.2022 09:59:32 Final meter reading entry Start mtr reading 000001,81 kWh Final mtr readg: 000000,00 kWh Check Cancel</p>
<p>After entering the start value, press "Next" to enter the final value. (Called up after touching one of the two buttons).</p>	<p>After entering the final value, press "Check".</p>
<p>13.04.2022 10:00:42 Start mtr reading: 1,81 kWh Final mtr readg: 1,81 kWh Consumption: 0,00 kWh Start: 13.04.2022 09:22:28 End: 13.04.2022 09:23:08 Duration: 00:40 ID: 98Df456Hgt43 EVSEId SAM-001 (12)</p>	<p>13.04.2022 10:00:25 Start mtr reading: 1,81 kWh Final mtr readg: 1,81 kWh Consumption: 0,00 kWh Start: 12.04.2022 14:48:39 End: 12.04.2022 14:51:35 Duration: invalid ID: 33Df9932fr4166 EVSEId SAM-001 Next 1/2 (13)</p>
<p>Screen output for a found entry.</p>	<p>If there are several data sets (possible with a charge of ≤ 0Wh), scrolling is possible.</p>

<p>Possible information screens</p>	
<p>13.04.2022 10:00:25 Start mtr reading: 1,81 kWh Final mtr readg: 1,81 kWh Consumption: 0,00 kWh Start: 12.04.2022 14:48:39 End: 12.04.2022 14:51:35 Duration: invalid ID: 33Df9932fr4166 EVSEId SAM-001 Next 1/2 (13)</p>	<p>13.04.2022 09:22:50 Consumption: 0,00 kWh Start: 13.04.2022 09:22:28 Duration: invalid ID: 98DfXXXXXXXXX EVSEId SAM-001 > Charging active <</p>
<p>"Invalid" notice in the charging process summary if there was a communication problem. The data set is not billable according to time!</p>	<p>Notice if there was a communication problem during the charging process. The data set is not billable according to time!</p>

Possible error screens	
<p>19.12.2021 07:54:27</p> <p>Limited operation</p> <p>Billing not possible on basis of measured values</p> <p>Data query possible</p>	<p>19.12.2021 07:54:12</p> <p>Billing not possible based on the measured values</p>
Error message: there is a communication or memory problem.	Error message: there is an internal fault in the SAM.
<p>19.12.2021 07:53:47</p> <p>Entry not found</p> <p>Renewed</p> <p>Cancel</p>	<p>19.12.2021 07:53:47</p> <p>Entry not found</p> <p>Renewed</p> <p>Cancel</p>
Error message: no entry was found. Billing is only possible with a data set that complies with calibration law!	Error message: the data set found is inconsistent. The data set does not comply with calibration law and is therefore cannot be billed!

Lock screen	
<p>19.12.2021 07:54:32</p> <p>Data verification blocked</p> <p>Next check option in 13 seconds</p> <p>Ok</p>	
Lock screen after 5 incorrect queries/entries	

2.5.2 Overview of all displays (examples)

Info screens (without interaction with the user)

<p style="text-align: center;">Compleo CS - SAM</p> <p>SAM S/N: SAM-AA11112 Meter S/N: 1 ESY11 61132767 HW: V1.0 SW: V1.4.4-dirty Checksum: 0x6A72 Production date: 04.03.2022 charge possible: 65462</p>	<p style="text-align: right;">19.12.2021 07:54:22</p> <p>TYP2: Right126 CCS5 12345</p> <p style="text-align: center;">Ready for operation</p>
Boot screen	Ready for operation (idle state)
<p style="text-align: right;">13.04.2022 09:22:12</p> <p>ID: 98Df456Hgt43 TYP2: SAM-001</p> <p style="text-align: center;">Ready for operation</p>	<p style="text-align: right;">13.04.2022 09:22:12</p> <p>ID: 98Df456Hgt43 TYP2: SAM-001</p> <div style="background-color: black; height: 15px; width: 100%;"></div> <p style="text-align: center;">Ready for operation</p>
Display of the ID after a successful authorisation.	2 second progress bar (from left to right) until the timing starts.
<p style="text-align: right;">13.04.2022 09:22:28</p> <p>Consumption: 0,00 kWh Start: 13.04.2022 09:22:28 Duration: 00:00:01.5 ID: 98Df456Hgt43 EVSEId SAM-001 >>> Charging active <<<</p>	<p style="text-align: right;">13.04.2022 09:22:50</p> <p>Consumption: 0,00 kWh Start: 13.04.2022 09:22:28 Duration: invalid ID: 98DfXXXXXXXXXX EVSEId SAM-001 > Charging active <</p>
Current measured values. The number of arrow symbols represent the number of loaded phases.	After a few seconds, the last digits of the ID are substituted.
<p style="text-align: right;">13.04.2022 09:22:50</p> <p>Consumption: 0,00 kWh Start: 13.04.2022 09:22:28 Duration: 00:00:25 ID: 98DfXXXXXXXXXX EVSEId SAM-001 Charging active</p>	<p style="text-align: right;">13.04.2022 10:00:42</p> <p>Start mtr reading: 1,81 kWh Final mtr readg: 1,81 kWh Consumption: 0,00 kWh Start: 13.04.2022 09:22:28 End: 13.04.2022 09:23:08 Duration: 00:40 ID: 98Df456Hgt43 EVSEId SAM-001 <div style="background-color: black; color: white; padding: 2px; display: inline-block;">(12)</div></p>
Display of duration with tenths of seconds, only in the first minutes after the start.	Summary at the end of the charging process.
Interactive screen displays with the user to invoke charging procedures.	

<p>13.04.2022 09:58:41</p> <p>Start meter reading entry</p> <p>Start mtr reading 000000,00 kWh</p> <p>Next Cancel</p>	<p>13.04.2022 09:59:32</p> <p>Final meter reading entry</p> <p>Start mtr reading 000001,81 kWh Final mtr readg: 000000,00 kWh</p> <p>Check Cancel</p>
<p>After entering the start value, press "Next" to enter the final value. (Called up after touching one of the two buttons).</p>	<p>After entering the final value, press "Check".</p>
<p>13.04.2022 10:00:42</p> <p>Start mtr reading: 1,81 kWh Final mtr readg: 1,81 kWh Consumption: 0,00 kWh</p> <p>Start: 13.04.2022 09:22:28 End: 13.04.2022 09:23:08 Duration: 00:40</p> <p>ID: 98Df456Hgt43 EVSEId SAM-001</p> <p style="text-align: right;">(12)</p>	<p>13.04.2022 10:00:25</p> <p>Start mtr reading: 1,81 kWh Final mtr readg: 1,81 kWh Consumption: 0,00 kWh</p> <p>Start: 12.04.2022 14:48:39 End: 12.04.2022 14:51:35 Duration: invalid</p> <p>ID: 33Df9932fr4166 EVSEId SAM-001</p> <p style="text-align: right;">Next 1/2 (13)</p>
<p>Screen output for a found entry.</p>	<p>If there are several data sets (possible with a charge of ≤ 0Wh), scrolling is possible.</p>

<p>Possible information screens</p>	
<p>13.04.2022 10:00:25</p> <p>Start mtr reading: 1,81 kWh Final mtr readg: 1,81 kWh Consumption: 0,00 kWh</p> <p>Start: 12.04.2022 14:48:39 End: 12.04.2022 14:51:35 Duration: invalid</p> <p>ID: 33Df9932fr4166 EVSEId SAM-001</p> <p style="text-align: right;">Next 1/2 (13)</p>	<p>13.04.2022 09:22:50</p> <p>Consumption: 0,00 kWh</p> <p>Start: 13.04.2022 09:22:28</p> <p>Duration: invalid</p> <p>ID: 98DfXXXXXXXXX EVSEId SAM-001</p> <p style="text-align: center;">> Charging active <</p>
<p>"Invalid" notice in the charging process summary if there was a communication problem. The data set is not billable according to time!</p>	<p>Notice if there was a communication problem during the charging process. The data set is not billable according to time!</p>

Possible error screens	
<p>19.12.2021 07:54:27</p> <p>Limited operation</p> <p>Billing not possible on basis of measured values</p> <p>Data query possible</p>	<p>19.12.2021 07:54:12</p> <p>Billing not possible based on the measured values</p>
<p>Error message: there is a communication or memory problem.</p>	<p>Error message: there is an internal fault in the SAM.</p>
<p>19.12.2021 07:53:47</p> <p>Entry not found</p> <p>Renewed</p> <p>Cancel</p>	<p>19.12.2021 07:53:47</p> <p>Entry not found</p> <p>Renewed</p> <p>Cancel</p>
<p>Error message: no entry was found. Billing is only possible with a data set that complies with calibration law!</p>	<p>Error message: the data set found is inconsistent. The data set does not comply with calibration law and is therefore cannot be billed!</p>
Lock screen	
<p>19.12.2021 07:54:32</p> <p>Data verification blocked</p> <p>Next check option in 13 seconds</p> <p>Ok</p>	
<p>Lock screen after 5 incorrect queries/entries</p>	

Explanation of the display positions

Text displays during boot screen after switching on and restarting the SAM.	
SAM S/N	Serial number of the SAM
Meter S/N	Serial number of the meter
HW	Placeholder
SW	Firmware version
Checksum	Firmware checksum
Production date	Day of manufacture (day of programming)
Charging processes	Number of charging processes that are still possible and can be saved.
Text displays during operation of the charging column.	
Date & time	The current date and time are permanently displayed in the first line. The date is displayed in the format dd.mm.yyyy, the time is displayed in the format hh:mm:ss.
Initial reading	The initial value represents the meter reading at the beginning of a specific charging process. It is displayed during a charging process and also when a completed charging process is displayed. The display is in kilowatt hours.
Final reading	The final value is displayed after finishing and when retrieving a finished charging process. The display is in kilowatt hours.
Consumption	Difference between the initial value and the actual value. After completion of the charging process, it is the difference between the start and final value (power extracted). The display is in kilowatt hours.
Start	At this point, the start time of the charging process is recorded. Both the date and the time are relevant here.
End	At this point, the end time of the charging process is recorded. Both the date and the time are relevant here.
Duration	Time from the start of the charging process to the current time. When charging is complete, the total time from start to finish is displayed. The duration is displayed in the format hh:mm:ss ss or, from a duration of 1 day, in the format dd:hh:mm.
ID	The user ID used for authorisation is shown here. During the charging process, this cannot be recognised except for a few leading digits.
Typ2	- Delivery point has a type 2 plug.
CCS	- Delivery point has a CCS plug.
CHA	- Delivery point has a CHAdeMO plug.

2.6 SAM system overview

The SAM forms a unit with the associated meter, which is used to record and store measured values.

The following image shows the functional arrangement of the SAM (green) in a charging station.

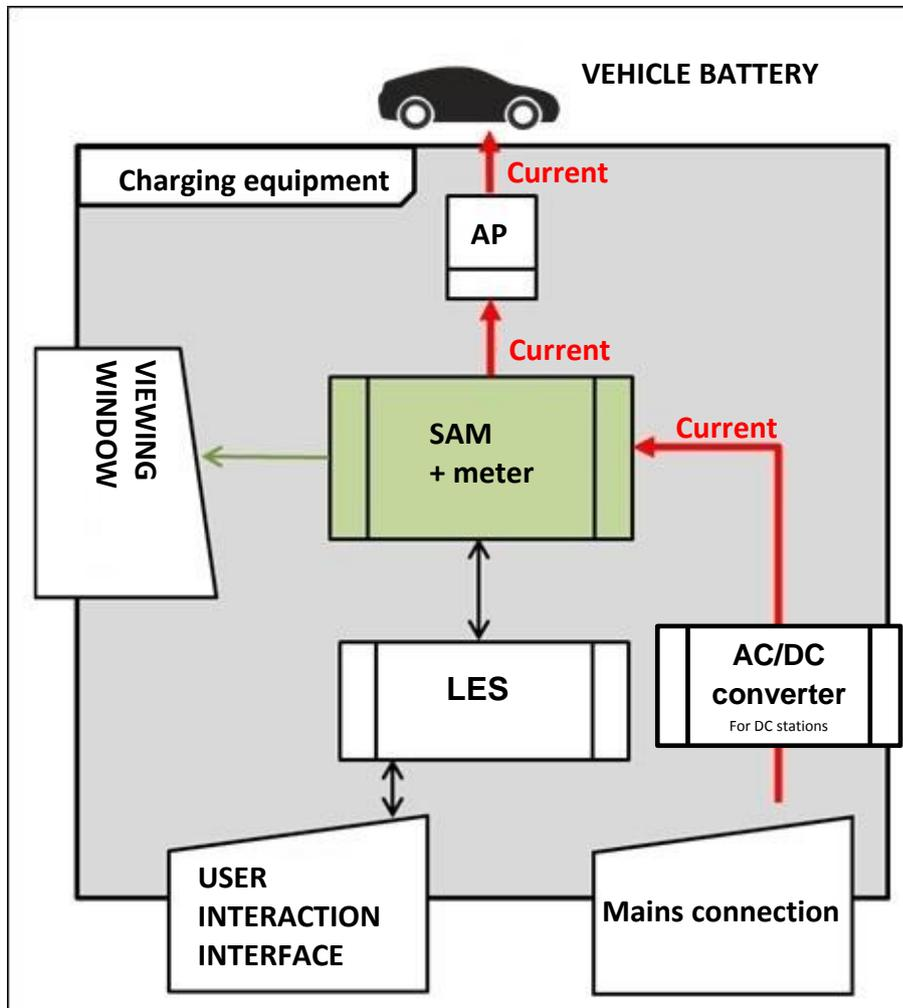


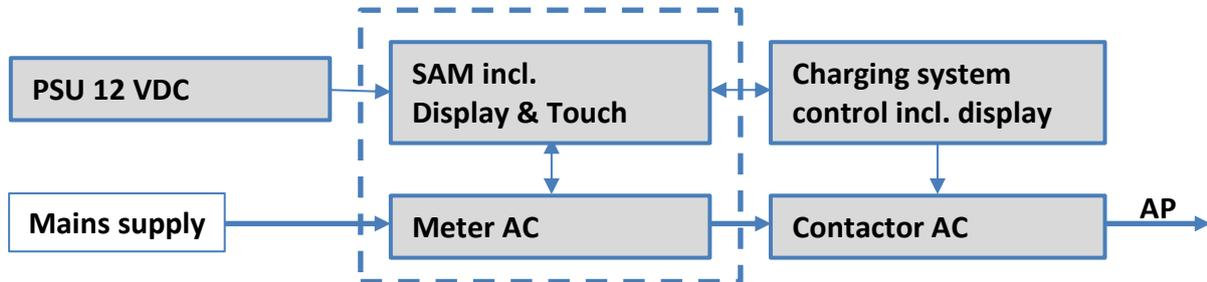
Figure 4: Functional arrangement of the SAM in an AC charging station

For DC charging stations, an AC/DC converter is also used between the mains connection and the measuring capsule (SAM + meter).

2.7 Integration of the subsystem in a charging column

With the subsystem, it is possible to carry out all measurements and data collection. The following illustrations show the required connections between the components within a charging column.

AC system



DC system

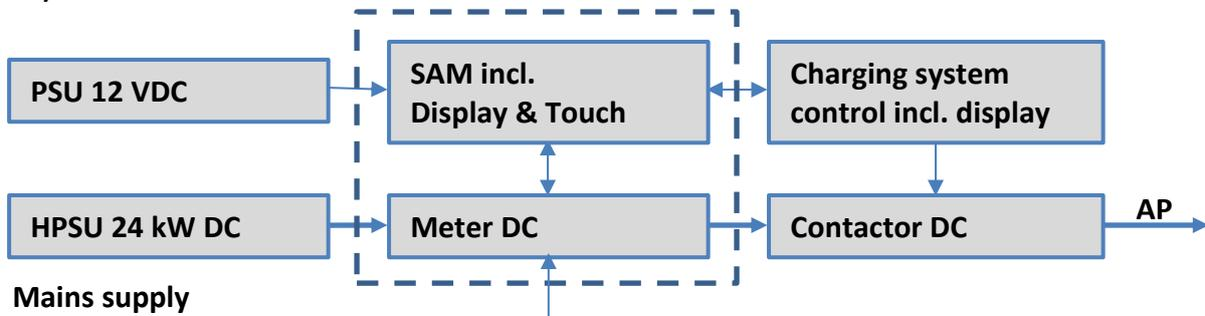


Figure 5: Integration of the subsystem in a charging column (for AC and DC version)

On the left is the 12 V power supply for the SAM and the control unit. In the immediate vicinity is the mains supply line to the AC meter (LS fuses and other components may be connected upstream here) or the DC power unit to the DC meter.

On the right is the control unit that communicates with the SAM module via the 20 mA interface and controls the contactor (AC and DC) to release the energy to the AP.

The SAM (measuring capsule) is shown in the centre (dashed frame).

2.8 Communication connections

The SAM is equipped with the following non-reactive communication interfaces:

- IR interface: Point-to-point connection to the electricity meter
- 20 mA interface: Point-to-point connection to the charging system control unit (LES)
- HMI interface (2 buttons and display) for interaction with the user

Connection to the electricity meter

The memory and display module is connected to the electricity meter via a secure connection. This connection is established via an optical interface.

Depending on the operating state, the values are

- automatically sent out cyclically by the meter or
- - actively queried by the SAM.

Connection to the LES

The memory and display module is connected to the LES via a 20 mA interface (current loop). The SAM sends the received meter values unchanged to the control unit. In addition, the result of a start and final meter reading query is transmitted.

The control unit sends the following information to the SAM:

- Start of the charging process for the corresponding delivery point
- End of the corresponding charging process
- ID for the associated start and final meter reading
- Date and time
- Voltage
- Correction factor (resistance to system power loss)

2.9 Power supply

In the AC system, the AC meter is connected to the mains connection on the input side via electrical protective measures such as charging station fuses and main switches. On the output side, the delivery point (AP) is supplied with power via an AC contactor. The user can charge his vehicle via the delivery point (socket or charging cable).

For the DC system, the DC meter is connected on the input side via an AC/DC converter with integrated protective devices. On the output side, the delivery point (AP) is supplied with power via DC contactors.

2.10 SAM module system overview

The following image shows the internal relevant components of the SAM.

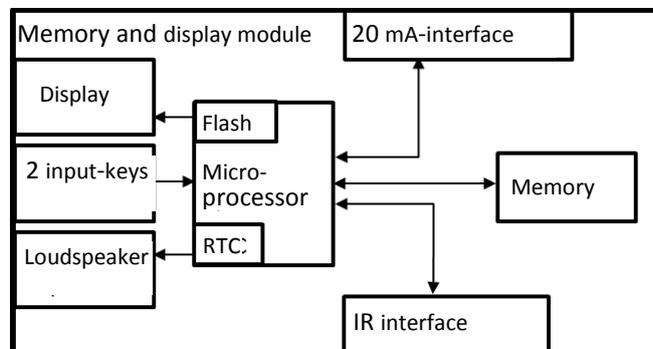


Figure 6: Functional block diagram of the SAM

The memory and display module is equipped with the following components:

Micro-controller

The micro-controller has an integrated flash memory and an RTC.

The flash memory is used for the firmware (without update function).

The RTC is used for the calendar, time and stopwatch function.

Additional flash memory

The additional and non-volatile long-term memory is used for storing charging processes and can be read out by the control unit.

The following data is collected and stored as a tuple:

- | | | |
|------|--------------------------|---|
| (1) | RecordId (1 byte) | Identifier byte assigned to memory entry for charging data |
| (2) | StartTime (4 byte): | Date and time at the start of the loading process |
| (3) | StartTimeOffset (2 Byte) | UTC offset at start |
| (4) | EnergyStart (4 byte): | Meter reading at the start of the charging process [kWh] |
| (5) | Authentication-Id: | ID (21 byte) |
| (6) | SLIN (1 byte): | Security level of the ID |
| (7) | ParameterRef-Id (2 byte) | Reference to parameter set |
| (8) | Reserved (13 byte): | Reserved area |
| (9) | CRC_Begin (2 byte): | CRC over all written values at the start time |
| (10) | EndTime (4 byte): | Date and time at the end of the loading process |
| (11) | EndTimeOffset (2 byte) | UTC Offset at stop |
| (12) | EnergyStop (4 byte): | Meter reading at the end of the charging process [kWh] |
| (13) | ValidityStatus (2 byte): | Bit0: No communication from the meter with MeasureStop
Bit1: Measuring duration not valid
Bit2: CRC error in the data set |
| (14) | CRC_Complete (2 byte): | CRC over all written values |

IR interface (optical)

The IR interface is used for communication with the MID electricity meter.

20 mA current interface

The 20 mA current interface is used for communication with the control unit.

Display

The display is used to show values relevant to the bill and to check the input of the bill data.

Input keys

The two capacitive input keys can be used for function selection and meter reading input by the user.

Loudspeaker

The loudspeaker is used for acoustic feedback, e.g. when keys are touched.

12 V supply connection

The SAM is supplied with 12 V operating voltage via the connection

2.11 Time measurement of the charging service duration (stopwatch function)

The SAM has an internal quartz-controlled real time clock (RTC). This is used for time measurement (for the charging time or standing time).

The charging service time is the time between the moment the charging equipment detects the connection of a vehicle and the moment the charging equipment detects the disconnection of the vehicle from the charging equipment.

The start condition for recording the charging service duration is successful authorisation at the charging station and the connection to the vehicle (plug inserted on both sides).

The stop condition for recording the charging service duration:

1. For a charging line connected at the charging point of the charging equipment, the disconnection of the to the charging equipment (the trigger is the disconnection of the control pilot signal of the pilot circuit according to EN 61851-1).
2. For a socket at the charging point of the charging equipment, the disconnection of the external charging cable at the charging station.

Internally, the time is measured with a resolution of one millisecond. The time is shown to the second on the display (for clarity), with the milliseconds truncated. This means that the seconds display does not show rounded values. The following figure illustrates this.

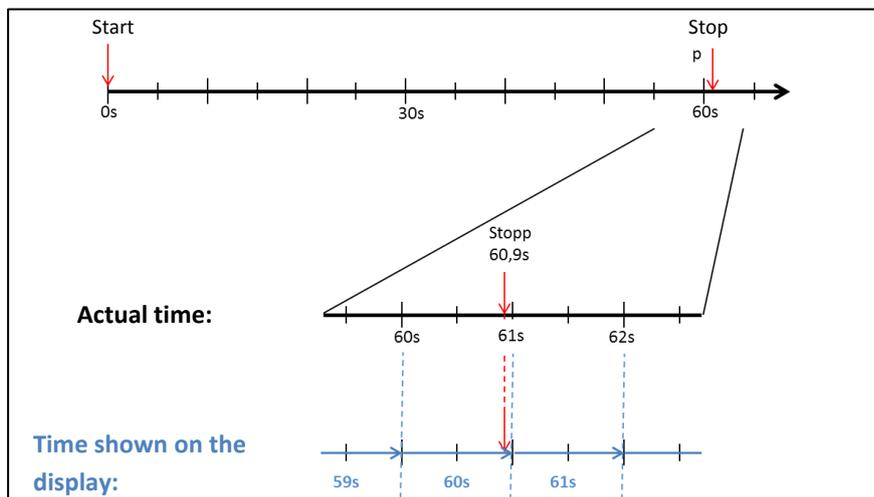


Figure 7: Measurement period on the display is not rounded.

The options for checking this time measurement are described below.

Checking the time measurement by means of the display

In the display, a start bar accurate to the second is also shown, which begins a 2 second countdown (bar progresses from left to right) after the charging column is connected to the vehicle. The time starts to be measured after the countdown. The measurement stops when the vehicle is disconnected from the charging station.

NOTE

The stopwatch continues to run after charging has stopped.

If the vehicle has its own charging cable, it is not sufficient to simply unplug the vehicle. The time measurement only stops when the plug is pulled out of the charging station.

To check the stopwatch yourself, the start time can be recognised via the start bar and the accuracy of the stopwatch function can be checked via a stopwatch. The verification time should be at least 10 minutes in order to demonstrate sufficient accuracy. According to the standard, a deviation of 1% is permissible.

Checking the time measurement by means of the data interface

The time measurement accurate to a millisecond can be read out from the SAM via the available 20 mA interface using the SML protocol.

Checking the time measurement in the manufacturing process

In each SAM, a connection pin is available which signals the start and stop time by means of a signal change (flank-controlled). With this signal in combination with the digital time measurement value (via the 20 mA interface), all SAMs are checked in the manufacturing process for the functionality and accuracy of the internal RTC.

The following diagram illustrates the check procedure.

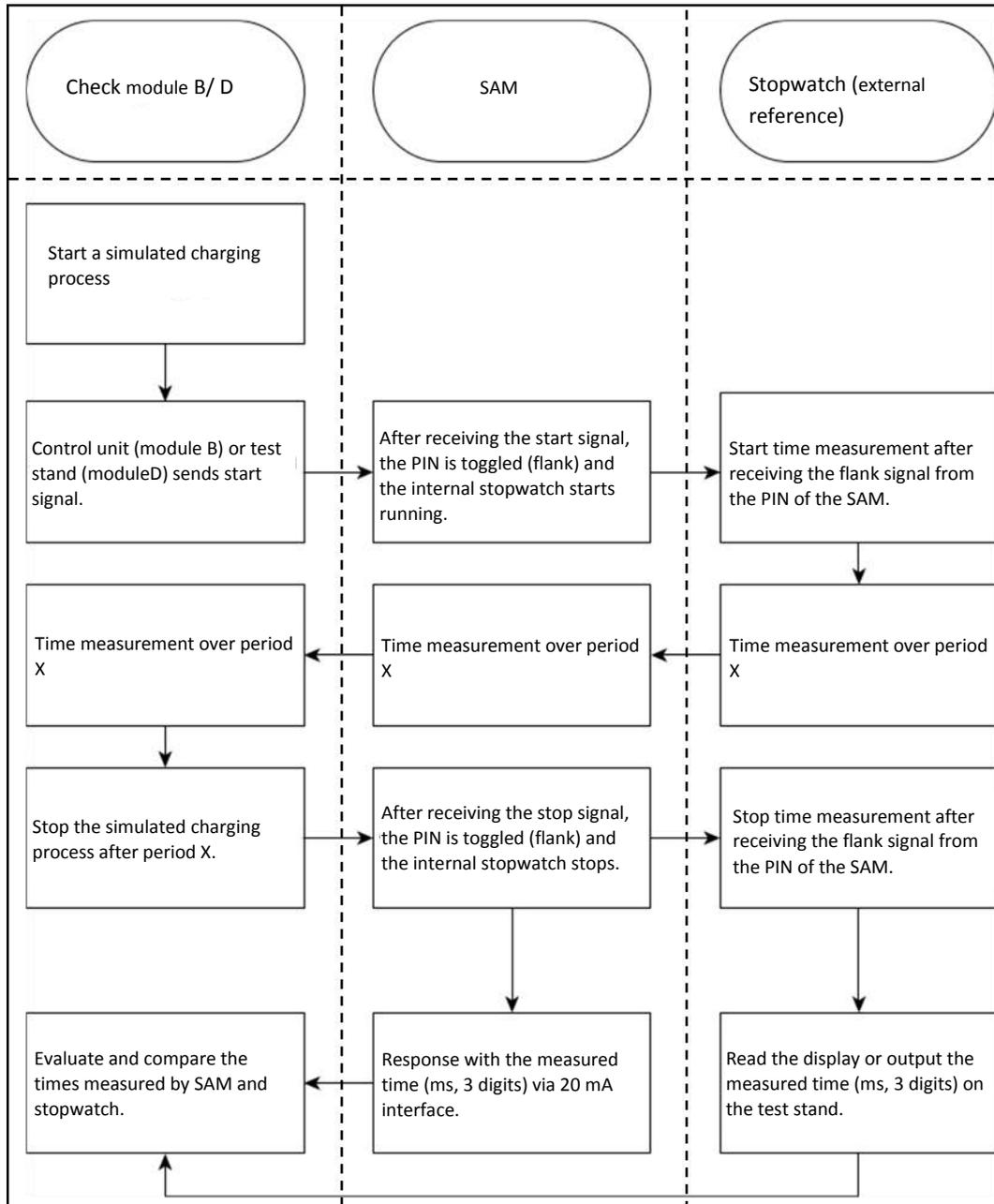


Figure 8: Test procedure regarding the stopwatch function in the manufacturing process.

System overview of electricity meter

The meter is an approved meter under calibration law and is used to measure the amount of energy delivered to the delivery point.

The following picture shows the meter with its functional components.

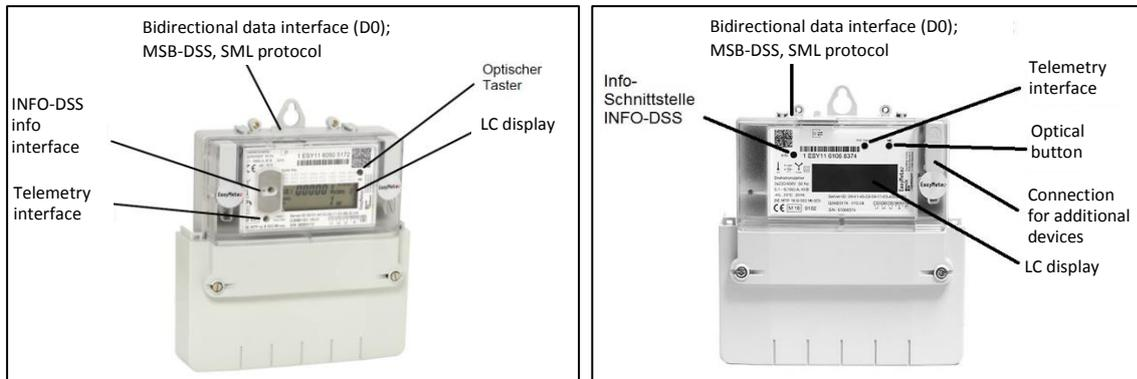


Figure 9: EasyMeter meter (example)

LC display

The display is a non-backlit liquid crystal display (LCD).

Optical button (not used by the SAM module)

The "optical keystroke" requires an optical energy equivalent of 400 LUX (e.g. torch) and is used to display additional information of the meter.

Data interfaces (MSB and INFO-DSS)

The potential-free data interface of the meter is a bidirectional, optical (infrared) communication interface for communication with the SAM module.

Info interface (not used by the SAM module, interface only for AC)

The meter has a potential-free optical data interface (INFO-DSS). The info interface is a unidirectional, infrared communication interface.

Telemetry interface (not used by the SAM module)

The telemetry interface is an infrared optical test output according to EN50470-1 (pulse output).

3 Charging process with SAM

This chapter explains in more detail the displays that are shown in the SAM during a charging process. For information on how to charge at a charging station, please refer to the operating instructions for the respective charging station.

3.1 Readiness

After the boot process, the SAM is ready for operation. The current date and time are displayed. If the display illumination is deactivated due to prolonged inactivity or restart, it can be activated by pressing one of the two keys.

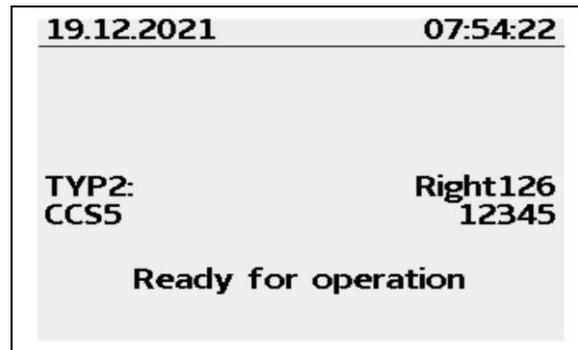


Figure 10: Readiness display (example)

3.2 Authorisation

As soon as a user logs into the charging station and receives the corresponding authorisation to charge, the display changes and shows the corresponding ID for the upcoming charging process.

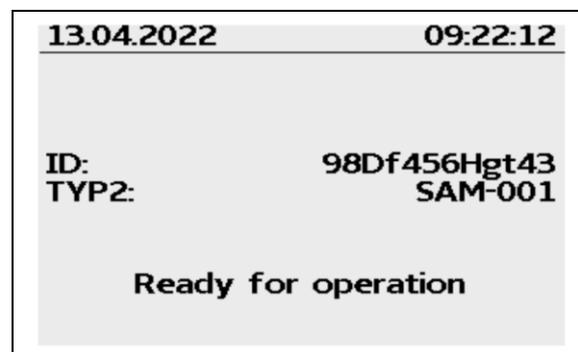


Figure 11: Display after authorisation (example)

3.3 Two seconds until charging

As soon as a vehicle and the charging column are connected and the authorisation was successful, a black two-second progress bar (from left to right) is shown in the display.

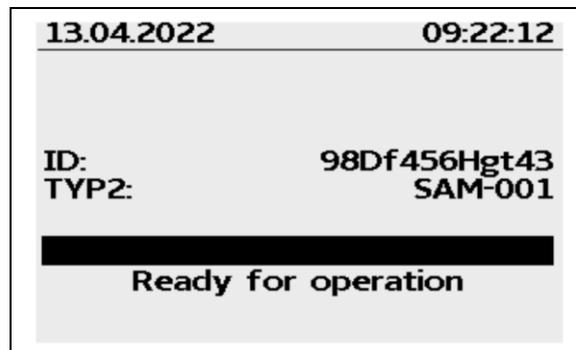


Figure 12: Two-second progress bar (example)

3.4 Charging process

After this time has elapsed, the display changes to the next representation and the time measurement begins. During the entire charging process, the current information is shown on the display as in the following illustration.

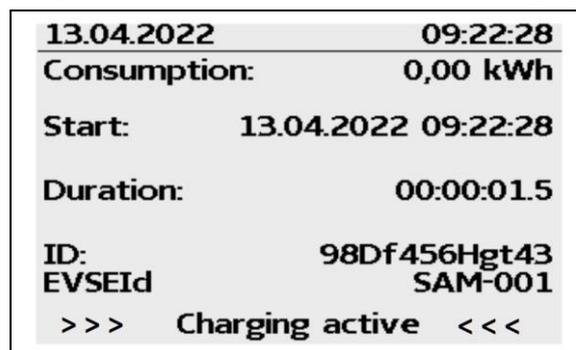


Figure 13: Active charging process (example)

In the last line, in addition to the information text "Charging active", the large and small characters (arrow symbols) are displayed. The number of characters indicates, here three on each side, that all three phases in the charging line supply energy. If only two or only one character is displayed on each side, then correspondingly fewer phases provide energy. This depends on the onboard charger installed in the vehicle. Information about the installed onboard charger can be obtained from the car dealer or from the associated instructions for the vehicle.

If no characters are displayed, then the vehicle's battery probably cannot be charged any further.

NOTE

A few seconds after the start of the charging process, the personal ID is substituted by crosses except for a few leading digits for data protection reasons.

3.5 End of the charging process

After the charging process is completed (after disconnection from the vehicle¹ on the charging station side), the information is shown on the display for checking purposes. The display can be extended by a further 20 seconds by pressing the right key and it closes automatically after this period has elapsed.

13.04.2022	10:00:42
Start mtr reading:	1,81 kWh
Final mtr readg:	1,81 kWh
Consumption:	0,00 kWh
Start:	13.04.2022 09:22:28
End:	13.04.2022 09:23:08
Duration:	00:40
ID:	98Df456Hgt43
EVSEId	SAM-001
	(12)

Figure 14: End of the charging process (example)

NOTE

In order for the end user to be able to exercise the option of a billing check, there should be a visible indication for the customer that he should take a photo of the summary for this purpose (after the charging process!).

If the displayed time deviates by >75 min. from the real time, it is recommended not to use the charging station.

A measured value with a time duration < 60s must not be used for billing purposes!

¹If the vehicle has its own charging cable, it is not sufficient to simply unplug the vehicle. The time measurement only stops when the plug is pulled out of the charging station.

4 Query previous charging processes with SAM

4.1 Query via backend

Using OCPP, individual or all stored data sets can be retrieved from the backend via the charging equipment control unit.

4.2 Query on site

Within the scope of saving all charging processes, the same can be called up after entering the start and final values of the meter readings of a specific charging process.

The following steps can be carried out using the two keys on the SAM. The left key is always used to advance the cursor to the next selection option and the right key to select an option or increase the selected digit. The currently selected position appears on a dark background.

The options at the bottom of the field cannot be selected directly by pressing the keys below, but are selected one after the other with the left key according to the individual digits. After selecting the last available option, the last digit is selected again so that corrections can be made without aborting.

Entering the start value

The start value of the charging process to be queried is to be entered as previously described. Then select the "Next" option and confirm.

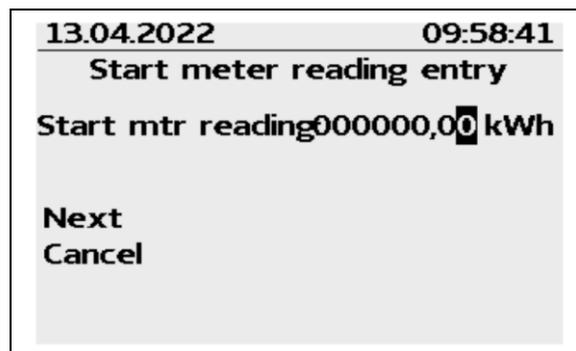


Figure 15: Entering the start value (example)

Entering the final value

The final value of the same charging process is entered in the same way. Selecting the "Check" option outputs the desired information.

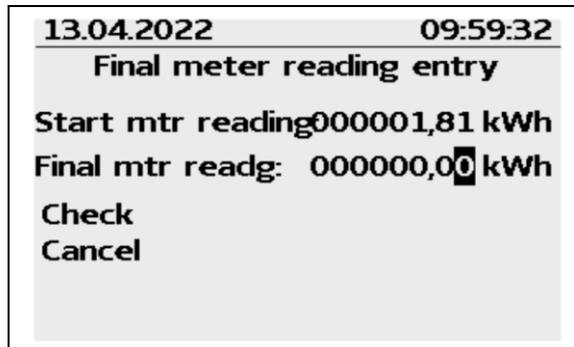


Figure 16: Entering the final value (example)

Display of the stored data

If the actual values are entered correctly, the information will be as shown in the illustration below. The display can be closed with the right key, but it also closes itself after an appropriate time window.

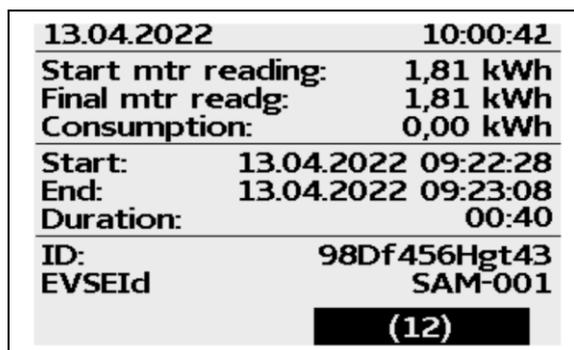


Figure 17: Output of the desired information (example)

If there are several data sets (possible with a charges ≤ 0 Wh), scrolling is possible.

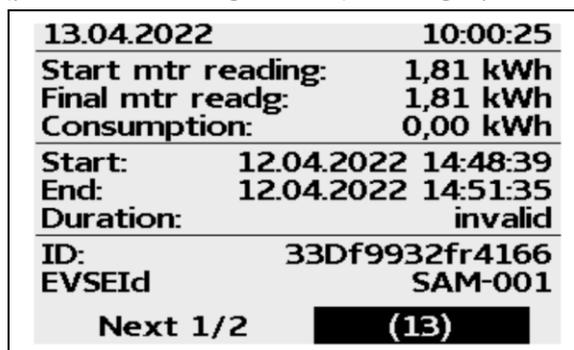


Figure 18: Example: further entries

Information screens

In certain situations, information screens are displayed if technical problems occur during a charging process.

The following information screens are displayed if either a power failure or the communication between the SAM and the control unit was interrupted during a charging process. Then the word "Invalid" is shown in the display under Duration.

13.04.2022	09:22:50
Consumption:	0,00 kWh
Start:	13.04.2022 09:22:28
Duration:	invalid
ID:	98DfXXXXXXXXX
EVSEId	SAM-001
>	Charging active <

Figure 19: Duration: Invalid, during a charging process (example)

Likewise, in the summary (at the end of the charging process), the word "Invalid" is shown in the display under Duration.

13.04.2022	10:00:25
Start mtr reading:	1,81 kWh
Final mtr readg:	1,81 kWh
Consumption:	0,00 kWh
Start:	12.04.2022 14:48:39
End:	12.04.2022 14:51:35
Duration:	invalid
ID:	33Df9932fr4166
EVSEId	SAM-001
Next 1/2	(13)

Figure 20: Duration: Invalid, in the summary after a charging process (example)

NOTE

Billing by time not possible!

If the duration is declared invalid, then the time measurement cannot be billed.

Error screens

Permanent error states in charging equipment cannot be excluded either. The following error screens are possible and are explained here.

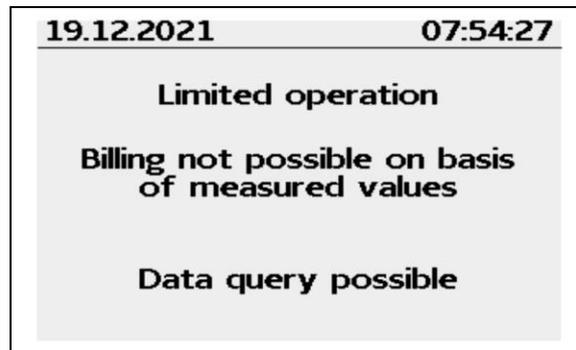


Figure 21: Limited operation (example)

"Limited operation" occurs when

- energy measurements are no longer possible. (e.g. meter is not working correctly).
Consequence: The charging point goes to "Out of service".
- the data memory is full or no further charging processes can be saved.
Consequence: Charging processes are still enabled, but these may not be billed.
- - the RCD trips during a charging process.
Consequence: The charging point goes to "Out of service" and the charging process is terminated.

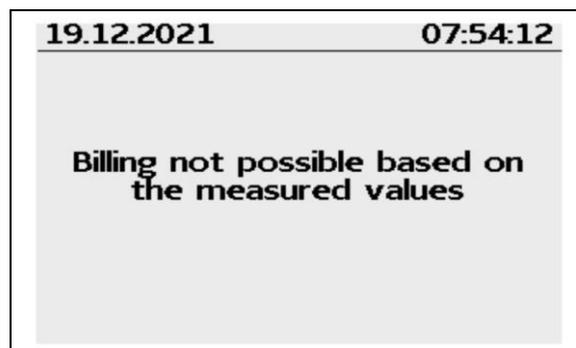


Figure 22: Out of service (example)

The SAM is "Out of service" when

- key operation no longer works.
Consequence: Charging processes are still enabled, but they may not be billed.
- the firmware of the SAM is inconsistent.
Consequence: The charging point goes to "Out of service".

NOTE

Bills may only be made with existing legally compliant data sets.



Figure 23: Entry not found (example)

An entry in the data memory cannot be found if

- the two start and end meter readings entered are not found in the data set (Tubel).
The operator has either entered incorrect values or has entered the data at an incorrect charging point (SAM).

NOTE

Only charging processes at the respective charging point are saved. There is no data exchange between the charging points.

Lock screen

The following picture shows the lock screen.



Figure 24: Lock screen (example)

This screen appears if five incorrect entries took place while entering readings to retrieve historical data. This function is intended to prevent misuse.

5 Technical data

Unless otherwise stated, the technical specifications are the same for all unit types.

5.1 Measuring capsule

Ambient conditions

Specification	Value	Unit
Approved installation site	Internal spaces or at least IP34 protected area	
Temperature range	-25 - +70	°C
Humidity	≤ 95	%
Mechanical/EMC requirement class:	M1/E2	

Technical data of the SAM nominal operating conditions

Specification	Value	Unit
Supply voltage	12	V
Power consumption	≤ 0.7	W
Protection class (housing)	IP 54	
Limit current I _{max}	≤ 60	mA
Range power factor cos φ during the charging process	0.9 - 1	
Electromagnetic environmental conditions	Testing was carried out according to DIN EN 50470	

Technical data of the meter nominal operating conditions

Specification	Value AC	Unit
Reference frequency (f _n)	50	Hz
Reference voltage	4-wire meter: 3 x 230/400 2-wire meter: 230 V at L3	V
Reference current I _{ref}	5	A
Limit current I _{max}	60	A
Actual starting current	10	mA
Minimum current I _{min}	100	mA
Transient current I _t	500	mA
Meter constant	IR LED output with 10,000	Imp/kWh
Terminals - Ø	8 terminals each with Ø 6.5 Screws 2 x M6 per terminal	mm
Protection class	II	
Protection class (housing)	IP 54	
Power consumption	Current path: ≤ 1,1 W at 60A Voltage path: ≤ 0.7 W/ 2 VA	
Auxiliary voltage	-	

5.2 Accuracy of the charging equipment

The accuracy of the charging equipment at the delivery point corresponds to that of an electricity meter of MID class A at nominal operating conditions.

6 SAM installation

6.1 Connections

The following illustrations provide an overview of the available connections. The SAM has a 6-pole plug-in connection for the 12 V operating voltage and the 20 mA interface, which is connected to the control unit.

The AC meter has connection terminals for the conductors L1 - L3 and the neutral conductor.

The DC meter has connection terminals for the plus and minus lines, sense lines and the auxiliary power supply (230 VAC).

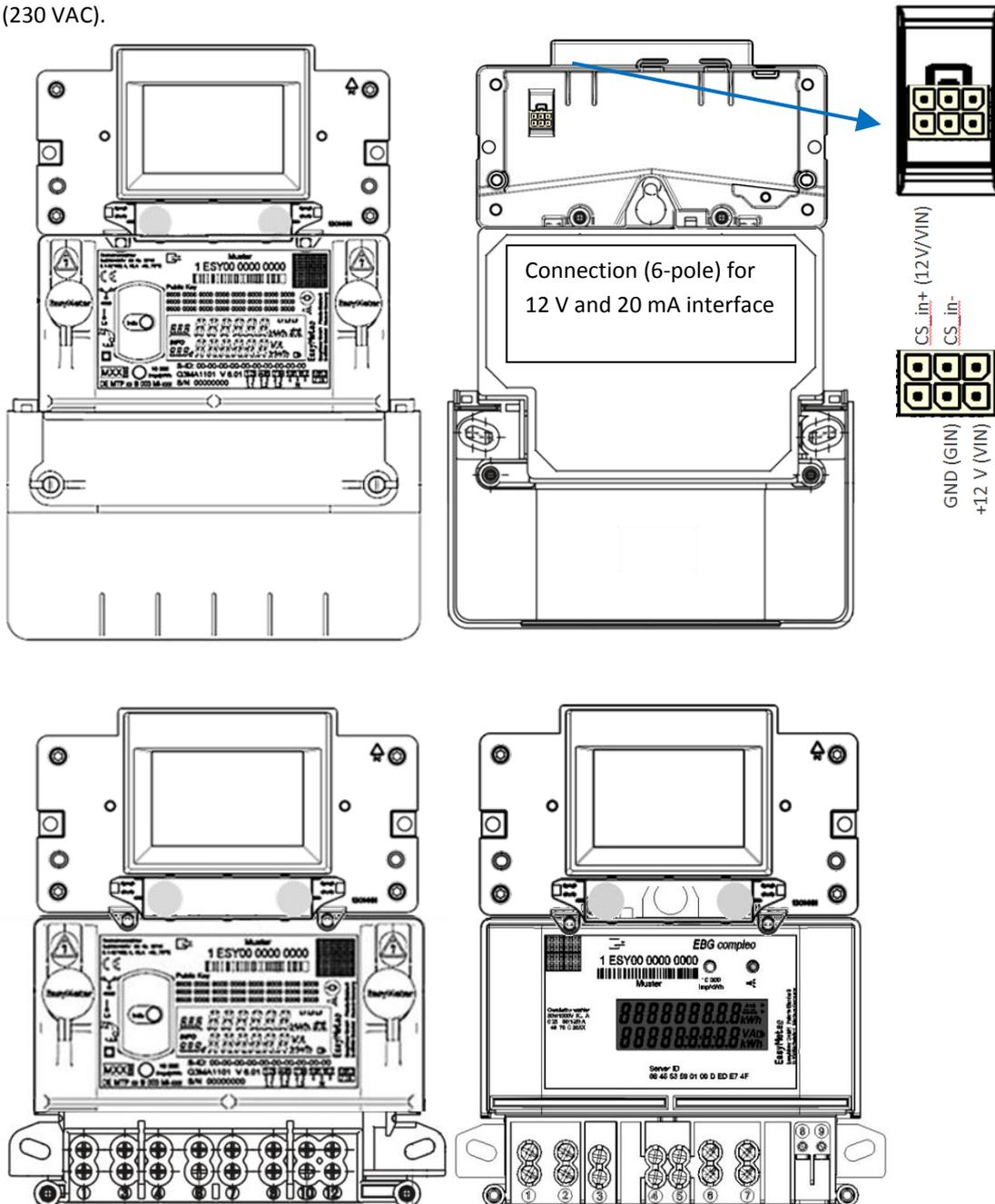


Figure25: Top: Front and rear with AC meter, below the representation of the connections; left AC, right DC ¹⁾

1) = not relevant for compleo Solo

6.2 Connection of SAM and meter

Please observe the following safety instructions before connecting the unit.

Specifications for the electrical connection

- The supply line must be hard-wired into the existing installation and comply with the nationally applicable legal requirements.
- The rated current I_N must be selected to match the back-up fuse and the circuit breaker.
- When designing the supply line, take into account the increased ambient temperatures inside a charging station or possible reduction factors. Increased line cross-sections may be necessary to adapt the temperature resistance of the supply line.

NOTE

The SAM as well as the meter must be connected when the system is de-energised.

The mounting position does not affect the functionality.

The tightening torque of the terminal screws 3 Nm (M6) must be observed.

The recommended conductor cross-section for connecting the meter is: Q3MB1020 ($I_{max} = 60A$) = 16mm²

Damage to property may occur due to incorrect connection!

WARNING

When connecting the meter, there is a risk of fire if the connection cables have too high an internal resistance!

Connecting the SAM to the controller

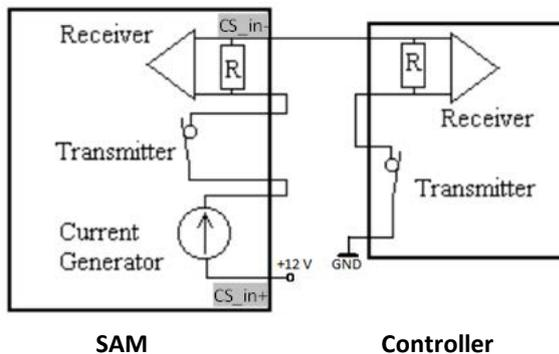


Figure 26: Wiring diagram SAM 20 mA interface to the controller

The pin assignment of the SAM is listed in the Connections chapter.

For the pin assignment of the controller, please refer to the corresponding operating instructions of the controller.

Connection of the meter to the supply network

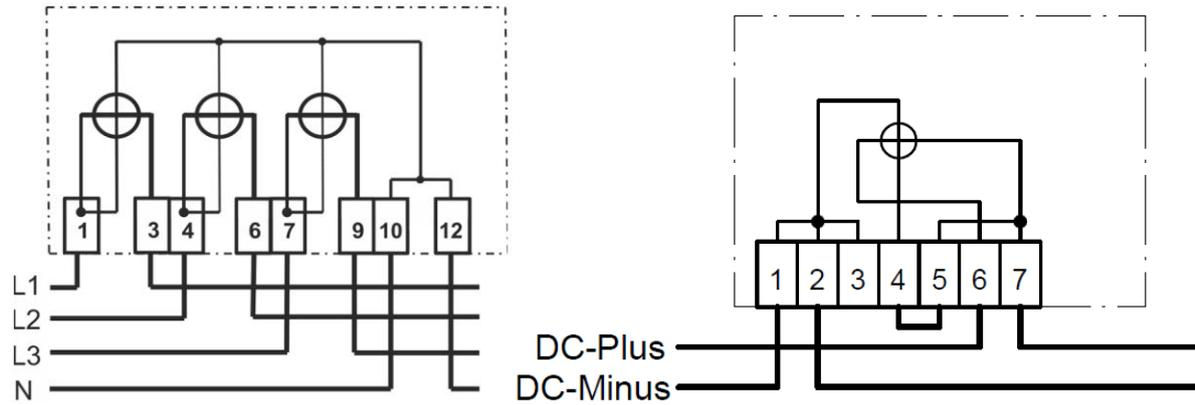


Figure 27: Connection diagrams for meter; left AC, right DC

Please refer to the charging station manufacturer's documentation for information on how the connection is made within a charging station.



Compleo Charging Solutions AG
Ezzestraße 8
44379 Dortmund
Deutschland

info@compleo-cs.com
compleo-charging.com



Compleo Charging Solutions GmbH & Co. KG

**Ezzestraße 8
44379 Dortmund
Germany**

**info@compleo-cs.com
compleo-charging.com**

©2023 Compleo. All rights reserved.

This document may not be copied or reproduced in any form or by any means, in whole or in part, without written permission. All illustrations in this document serve only as examples and may differ from the delivered product. All information in this document is subject to change without notice and does not represent a commitment on the part of the manufacturer.

Technical changes and errors excepted.